

REVIEW

Open Access



The state of the art and future trends of root canal files from the perspective of patent analysis: a study design

Jingang Jiang^{1,2*}, Jianpeng Sun¹, Zhiyuan Huang², Zhuming Bi³, Guang Yu⁴, Jingwen Yang^{5,6} and Yong Wang^{5,6*}

*Correspondence:

jiangjingang@hrbust.edu.cn;
kqcadc@bjmu.edu.cn

¹ Key Laboratory of Advanced Manufacturing and Intelligent Technology, Ministry of Education, Harbin University of Science and Technology, Harbin 150080, Heilongjiang, People's Republic of China

² State Key Laboratory of Robotics and System, Harbin Institute of Technology, Harbin 150001, Heilongjiang, People's Republic of China

³ Department of Civil and Mechanical Engineering, Purdue University Fort Wayne, West Lafayette 46805, USA

⁴ Department of Mechanical Engineering, Tsinghua University, Beijing 100084, People's Republic of China

⁵ National Engineering Laboratory for Digital and Material Technology of Stomatology, Peking University School of Stomatology, Beijing 100081, People's Republic of China

⁶ Peking University School of Stomatology, Beijing 100081, People's Republic of China

Abstract

The goal of this review is to present a detailed and comprehensive description of the published work from the past decade regarding methods of improved material, geometric design, and additional functions in root canal files. The main improved methods of files and the most common technologies were further addressed, underlining their advantages and main limitations. Online databases (the Derwent Innovations Index) were consulted on this topic. Published work from 2010 to 2022 was collected and analyzed the relevant papers were chosen for inclusion in this review. The patent map classified the latest phase of the root canal files based on the analysis of the number of patents. The performance of the root canal files, such as materials. Directly affects the quality of the root canal therapy. We provided a thorough review of advances in the field of root canal files. In particular, three categories of improved methods were examined and compared, including material-based methods, geometry-based methods, and those based on additional functions. To understand this state of the art of different improved methods of root canal files, we conducted a literature analysis and a series of comparisons between different methods. The features and limitations of each method of root canal files were further discussed. Finally, we identified promising research directions in advancing the methods for the improved performance of root canal files. There is no perfect technology for all material/geometric design/additional functions, capable alone of fulfilling all the specificity and necessities of every patient. Although it is very promising, the material of the files remains understudied, and further work is required to make material science a pervasive technology in root canal therapy, and contribute to endodontic and periapical diseases by assisting in the subsequent development of root canal files.

Keywords: Dental materials, Dental instruments, Patent analysis, Root canal therapy, Root canal file

Background

Endodontic and periapical diseases are the more common pathologies in dentistry [1, 2]. The cause of the disease is an invasion of bacteria into the pulp through periodontal or defective areas of teeth, causing infection, or through physical channels, causing



© The Author(s) 2022. **Open Access** This article is licensed under a Creative Commons Attribution 4.0 International License, which permits use, sharing, adaptation, distribution and reproduction in any medium or format, as long as you give appropriate credit to the original author(s) and the source, provide a link to the Creative Commons licence, and indicate if changes were made. The images or other third party material in this article are included in the article's Creative Commons licence, unless indicated otherwise in a credit line to the material. If material is not included in the article's Creative Commons licence and your intended use is not permitted by statutory regulation or exceeds the permitted use, you will need to obtain permission directly from the copyright holder. To view a copy of this licence, visit <http://creativecommons.org/licenses/by/4.0/>. The Creative Commons Public Domain Dedication waiver (<http://creativecommons.org/publicdomain/zero/1.0/>) applies to the data made available in this article, unless otherwise stated in a credit line to the data.

pain, bleeding, or even necrosis of the pulp [3]. Currently, the most effective treatment for endodontic and periapical diseases is root canal therapy [4]. Root canal therapy, also known as endodontic treatment, is a procedure in dentistry to treat necrotic pulp and root infections. The process of root canal therapy, i.e., mechanical preparation and chemical flushing to remove most of the infected material from the root canal [5, 6], followed by root canal filling and crown sealing [7]. The aim is to prevent the occurrence of periapical disease or to promote the healing of periapical disease that has already occurred [8]. Theoretically, the success rate of root canal therapy is between 83% and 97.1% [9]. However, the success rate of endodontic treatment is lower than the theoretical success rate, as shown in the surveys of the past decades [10]. The structural complexity of root canals, unskillful preparation technique, and insufficient performance of root canal files are all factors that contribute to the low success rate of root canal therapy in practice [11]. The solution to the first two problems will face great difficulties: for one, the root canal of a tooth is complex and variable, with a multidimensional curvature [12, 13], as well as many finer branches [14], which are inherent factors and cannot be changed artificially. Secondly, the current imbalance in the doctor–patient ratio in dentistry requires reliance on the clinician’s manual operation combined with extensive clinical experience, so it is difficult to improve preparatory technology in a short period. Therefore, to solve the current problem of low success rate, improvement of root canal file performance is a key aspect.

As an important tool in the mechanical preparation step, the quality of mechanical preparation is directly influenced by the performance of root canal files, which should create a regular and smooth tapered structure to avoid significant deviation from the original shape and orientation of the canal. The quality of mechanical preparation directly affects the success rate of root canal therapy. However, from the clinical use, the performance of root canal files does not meet the requirements of required mechanical preparation. As shown in Fig. 1(a), the poor performance of root canal files can cause several problems, such as apical inflammation, incorrect preparation, and instrument separation.

This paper introduced the main solution to these problems is to improve the performance of root canal files. The properties of files can be divided into mechanical properties and use properties. The deficiency of mechanical properties is reflected in material limitations and poor geometric design, and the deficiency of use properties is reflected in a single function. As shown in Fig. 1(b), the factors affecting the performance of root canal files and their current limitations were described. For dental medical devices [15–18] in dentistry, an extensive review of literature exists but a detailed overview of root canal files is, to the author’s best knowledge, missing.

The main motivation of this paper is to provide a comprehensive survey of improved methods of root canal files, focusing on the improved principles as well as improved characteristics of various methods, which are expected to improve therapeutic efficiency, reduce accident occurrence, lower costs, and eventually achieve the high-precision treatment of pulp disease and periapical disease, and occlusal relationship of patients can be reproduced.

The rest of the paper is organized as follows. In "Material" Section, this review proposed the methods of literature analysis and structure of this paper. Secondly, the root

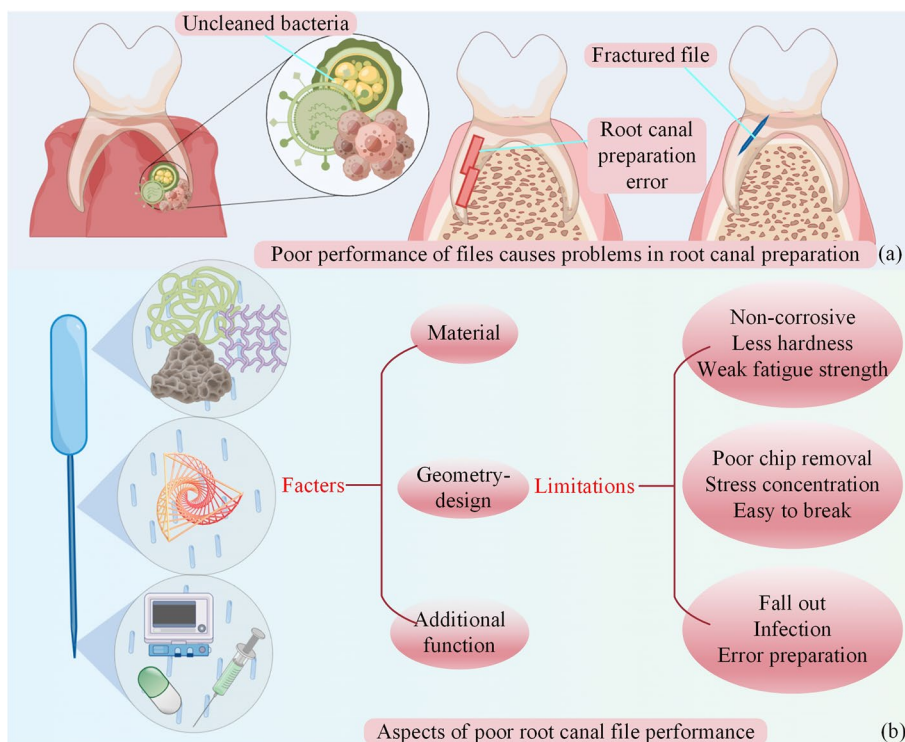

Fig.1 (Draw by Figdraw). Introduction to root canal therapy. **a** Problems of root canal therapy. **b** Problems with files

canal files were divided into materials, geometry, and functions, which are in "Additional function" Section. In "Discussion" Section and "Future trends" Section, the current status of root canal files and their future directions were discussed. Finally, the full paper is summarized in "Conclusion" Section.

Root canal files patent data acquisition

Mathematical and statistical methods were used in bibliometrics to quantitatively describe and evaluate various external characteristics of scientific literature to understand the state of research and predict trends in scientific and technological development. In this paper, Patentics [19, 20] was selected as the literature analysis tool. With the world's original Patentics intelligent semantic mathematical model, only by inputting a key technology point, the technology lineage and technology route related to the technology can be automatically analyzed by correlation clustering, and the high-precision correlation relationship from hyperspace can be projected to a 2D map space through the mapping of correlation retention. It can retrieve and download full text of patents of the US, Japan, China, Europe, and WIPO(PCT), and make patent analyses on retrieval results [21]. Patentics is currently used in the inspection of complex devices, such as chemical devices [22], circuit design devices [23], and biological devices [24]. Since a root canal file is just a little medical device, it is difficult to identify suitable search elements and conduct a targeted search during the search process due to the complexity of its structure and the wide range of fields involved. Patentics intelligent semantic search has rich search fields, and with reasonable human intervention, it can improve

the search efficiency of root canal upgrading methods, quickly browse the literature with novelty and creativity, and effectively improve the search efficiency. And as an important tool for treating endodontic disease, the effective retrieval of its elevation method is of great significance for treating endodontic and periapical diseases.

The Derwent Innovations Index was used as the main source of relevant literature by specifying the key technical point of the “root canal files,” the language of “English,” and the “core” collection of the Derwent Innovations Index. The corresponding search resulted in 626 documents from 1975 to 2022. The exported documents were analyzed by Patentscope to determine current research hotspots and key technologies in the field of root canal files. The keywords in Patentscope were selected for a co-occurrence network analysis. Based on the above mentioned, methods to improve the performance of root canal documentation can be deduced. As shown in Fig. 2, each keyword was taken as a node; there were 32 nodes in the co-occurrence network analysis. As shown by the nodes enclosed by dashed lines in the figure, the nodes within the dashed lines represent an enhancement method. The methods to improve the performance of root canal files were classified into 8 subcategories. The keywords represented by each node were marked in detail. If two keywords were used in one article, the corresponding nodes were met in the map. There were different colors to indicate different applicant rankings,

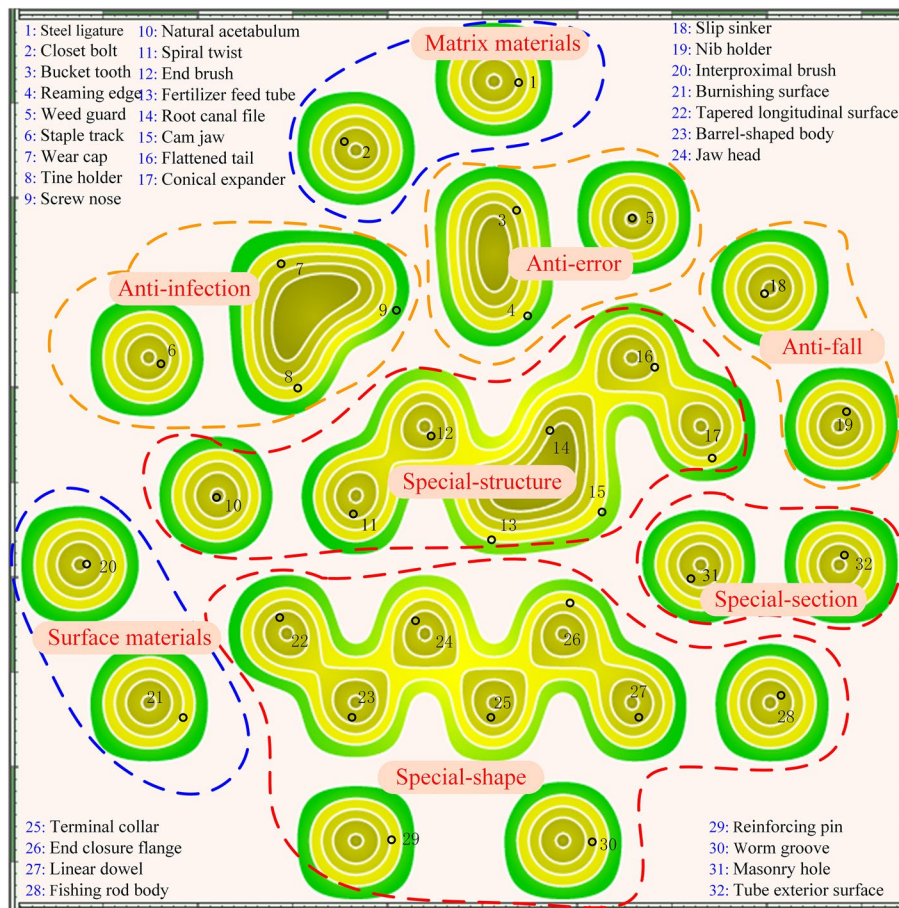

Fig. 2 Patent map of root canal files

and different positions indicate different applicant citations. The patent information was visualized as a contour topographic map to represent the peaks and valleys of patent distribution. The closer to the top of the mountain indicates that the keyword is hotter. The meaning of the same contour represents the proximity of the number of patents. The technology lineage and technology route related to the root canal files are shown in Fig. 2. According to the clustering results of the patent map, it can be found that the methods to improve the performance of root canal files mainly focus on three major methods: material, geometry, and additional function. The search strategy identified 626 potentially relevant records, and 445 remained after duplicate removal. Root canal therapy failure is characterized by the complexity of the root canal structure. Manual root canal files are often used in the preparation of such canals because mechanical root canal files are effective but difficult to control. In this paper, the focus is on manual root canal files because the goal is to improve the success rate of root canal therapy. After screening for title and timing, 87 studies from 2010 to 2022 were assessed as eligible.

So, in this paper, the root canal files of the last decade were classified into three major categories based on performance improvement methods: material based, geometry based, and those base on additional functions. Moreover, the methods of material based were divided into matrix material methods and surface material methods. The geometry-based methods were divided into special-shape methods, special-structure methods, and special-section methods. Additional function methods were divided into the anti-fall methods, anti-infection, and anti-error methods as shown in Fig. 3.

Classification of root canal files

Material

Statistical studies [25] have confirmed that the main reason for root canal therapy failure is the fragile performance of the instruments, which is the most common problem in the clinical use. But the probability of instrument fracture can be reduced by optimizing the mechanical properties of root canal files. Improvements in material properties,

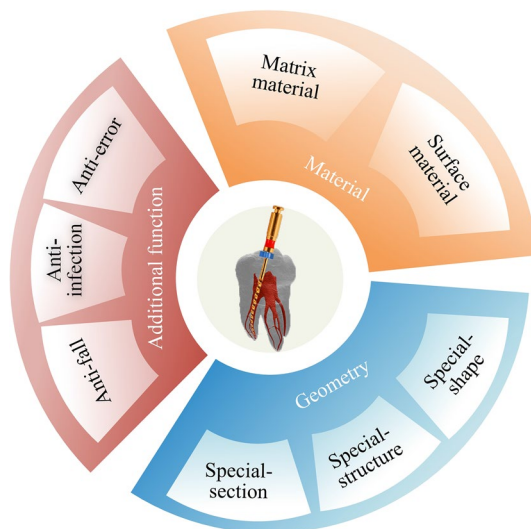

Fig. 3 Classification of root canal files according to performance

manufacturing process, and geometric design can improve the mechanical properties of root canal files, which are directly influenced by material properties. The common materials used for root canal therapy instruments are stainless-steel and nickel-titanium alloy, and the traditional stainless-steel root canal files have good cutting properties due to their high strength, so they can easily cause steps and lateral penetration on the inner surface of the canal [26]. Nickel-titanium has gradually replaced stainless-steel instruments as the tool of choice for root canal therapy [27] because of its significant advantages in terms of flexibility, formability, memory properties, and efficiency. However, in clinical use, nickel-titanium root canal files may break and separate due to material failure during multiple uses or when complex root canals are encountered [28]. For the problem of material failure, according to the different methods of improving material performance, this section has introduced the methods of improving materials into matrix material and surface material.

Matrix material

Nickel-titanium alloys were first used in the manufacture of root canal files by Walia [29] in 1988. With its good biocompatibility and damping properties, NiTi alloy can significantly improve the elasticity and fracture resistance of root canal files and reduce complications during root canal therapy. It is now widely used in clinical use [30]. However, when a nickel-titanium root canal file is used to prepare a bent root canal, it may break due to torsional fatigue or bending cycle fatigue, which can seriously affect the completion of the root canal therapy. Therefore, how to reduce fracture is the focus of clinical research [31]. Scholars have conducted numerous studies on the matrix materials intending to improve the fatigue resistance and flexibility of root canal files. These methods can be better adapted to the root canal pattern and reduce the risk of instrument separation during root canal treatment.

A gradient flexible nickel-titanium root canal files [32] was proposed by Wang Z. The files have excellent cutting properties, but the file material is not set for the preparation requirements of the root canal. Later, he improved the files according to the demand for material [33] in the different part of canal. The internal organization of the tip part of the root canal files was improved to the martensitic M phase, the middle part to the R phase, and the root part to the austenitic A phase. After this method of manufacturing, it can effectively prevent side penetration. This treatment solves the problem of hardness and wear resistance of existing nickel-titanium root canal files. Zheng YF proposed ultrafine-grain nickel-titanium alloy root canal files [34], and the preparation process is shown in Fig. 4(a). The material composition of the files is martensitic and austenitic when not in use, and austenitic in clinical use. From Fig. 4(d, e), it can be seen that the hardness and wear resistance of the superfine grain-treated nickel-titanium alloy and the superfine grain nickel-titanium alloy after heat treatment by holding at 400 °C for 60 min are improved [34]. As shown in Fig. 4(g–i), nickel-titanium and superfine grain nickel-titanium alloys are dominated by abrasive wear, while superfine grain nickel-titanium alloys after heat treatment are dominated by adhesive wear.

In order to solve the problem of large wobble at the end of the root canal file, many methods have been proposed by many scholars. Liu S proposed austenitic nickel-titanium alloy as the material for the connecting rod [35], and the threads at the edge are

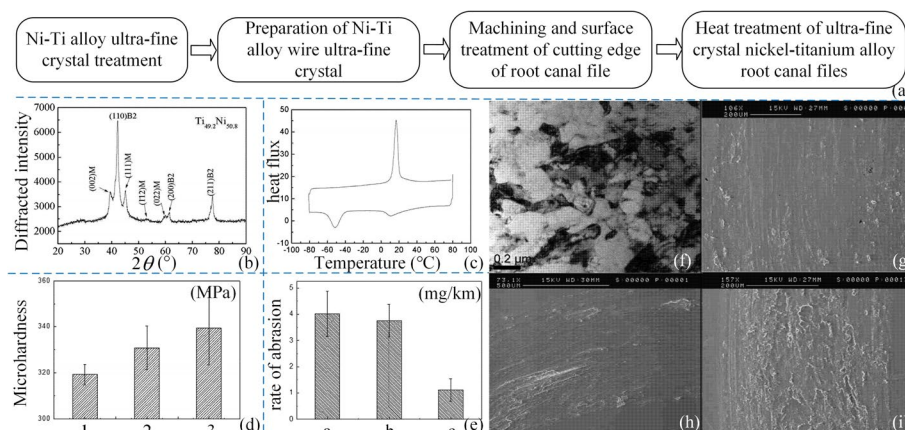

Fig. 4 Preparation of ultrafine-grained nickel-titanium alloy root canal files. Reproduced with permission. Source: CNIPA, www.cnipa.gov.cn. **a** The preparation process of ultrafine-grained nickel-titanium alloy root canal files. **b** XRD graph. **c** DSC curves. **d** Microhardness plots of nickel-titanium, superfine-grained nickel-titanium, and superfine-grained nickel-titanium alloys after heat treatment at 400 °C. Figures 1, 2, and 3 indicate the microhardness plots of nickel-titanium alloy and ultrafine-grain nickel-titanium alloy, and 3 indicates the microhardness plots of ultrafine-grain nickel-titanium alloy after heat treatment at 400 °C. **e** Wear rate diagrams of nickel-titanium alloy, ultrafine-grain nickel-titanium alloy, and ultrafine product nickel-titanium alloy after heat treatment at 400 °C. Figures a and b indicate the wear rate graphs of nickel-titanium alloy and ultrafine-grain nickel-titanium alloy, and c indicates the wear rate graph of ultrafine-grain nickel-titanium alloy after heat treatment at 400 °C. **f** Electron micrographs of the prepared ultrafine-grain nickel-titanium alloy root canal files. **g** Wear surface morphology of nickel-titanium alloy. **h** Wear surface morphology of ultrafine-grain nickel-titanium alloy. **i** Wear surface morphology of ultrafine-grain nickel-titanium alloy after heat treatment at 400 °C

machined from a martensitic nickel-titanium alloy. This type of root canal file can effectively reduce the oscillation of the blade. With the development of minimally invasive dental techniques, the use of minimal-size root canal files is required. However, the conventional material of root canal files is not designed for the micro-preparation of root canals and is prone to fracture. In response to this problem, Steven S proposed polymeric materials [36]. It includes stainless steel, nickel-titanium, titanium, carbon steel, plastic, carbon fiber, or composite materials. In response to the problem that root canal files are not easily removed after accidental breakage, Duan JH proposed biodegradable magnesium alloy root canal files [37]. When a root canal file is broken, a corrosive degradation reaction occurs when the magnesium alloy at the section encounters the root canal flushing fluid. Because magnesium is a macronutrient in the body, it has good biocompatibility and is harmless to humans.

Surface material

There are many advantages in nickel-titanium alloys, but their disadvantages cannot be ignored, such as low surface hardness and poor corrosion resistance in root canal irrigation fluids. And in mechanical preparation, due to factors, such as wear, corrosion, and fatigue, resulting in micro-cracks on the metal surface of nickel-titanium files at the same time, disintegrating metal debris will be produced. The metal debris reacts with the tissue fluid and residual flushing fluid that exudes from the root canal, which in turn leaches out metal particles that are harmful to humans. Some reports show that nickel-chromium alloys will produce varying amounts of nickel ions after 7 days of immersion

in artificial saliva. Due to the strong toxic side effects of heavy metal nickel ions on the human body, the release of nickel ions has become one of the indicators of biosafety evaluation of medical devices containing nickel metal [38]. In recent years, scholars have been working on surface modification techniques to improve the defects and deficiencies of root canal files in terms of biosafety, corrosion resistance, and fatigue fracture resistance [38–41]. For the surface modification of root canal files, the main modalities include polishing [42–45], coating metallic materials [53, 54], coating metals by magnetron sputtering process [56], and transition coating composite film [55].

Scholars have enhanced the properties of file surfaces by electrolytic polishing [42, 43], mechanical polishing [44], and chemical polishing [45]. Mechanical polishing can reduce the mechanical processing marks on the root canal files' surface and make the surface smoother, but the modification effect is not as significant as electrolytic polishing and chemical polishing. Electrolytic polishing and chemical polishing perform well in improving corrosion resistance and biocompatibility but are still affected by temperature and pH in the oral environment, and nickel ions can still precipitate from the surface of nickel-titanium root canal files and cause harm to humans [46]. To address this problem, surface coating technology can be an effective solution, which is more suitable for the surface modification of root canal files and can be achieved by coating the surface of nickel-titanium root canal files with a single film layer or a composite film layer to improve the performance [47–50]. It has been demonstrated [51] that the surface properties of the files can be improved by coating the surface of the nickel-titanium root canal files with a metal film to improve their hardness, wear resistance, and inhibit the precipitation of nickel ions from the surface. Zhang J proposed a method for the preparation of metallic titanium nitride oxide composite film [52], which can effectively inhibit the outward diffusion of nickel ions. The hardness and corrosion resistance of the surface of the nickel-titanium root canal files is improved while maintaining the original elasticity of the files. Huang BM proposed to wrap the metal tube layer by layer on the outside of the mandrel [53]. There is a certain margin between the metal tubes, and then the mandrel and metal tubes are drawn and annealed in one piece, which can make the root tube files have the advantages of no unscrewing, no fracture, and no jamming. Tenney R proposed a selective coating with coating materials [54], including metallic or non-metallic, inorganic-like fullerene structures, or complexes containing such nanostructures. The files itself is made of a composite of selected shape memory and super elastic materials. The selective coating, a solid lubricant, is used as a permanent coating, thereby reducing friction between the nickel-titanium root canal files and the root canal wall without affecting the unique properties of the shape memory alloy. However, the bond strength between the coating and the substrate may not be high.

For the problem of low bond strength between coating and matrix. Tong YX proposed the use of the magnetron sputtering process to deposit a metal coating on the surface of the root canal files [55]. Magnetron sputtering is the use of electric and orthogonal magnetic fields established on the target surface to control the targeted surface particles to be directed to the substrate surface, thus forming a coating on the substrate surface. The principle of magnetron sputtering is shown in Fig. 5(a, b) shows a schematic diagram of the cross-sectional material distribution of the root canal files after the above treatment. The hardness of the untreated and treated root canal files was tested using the HVS-100

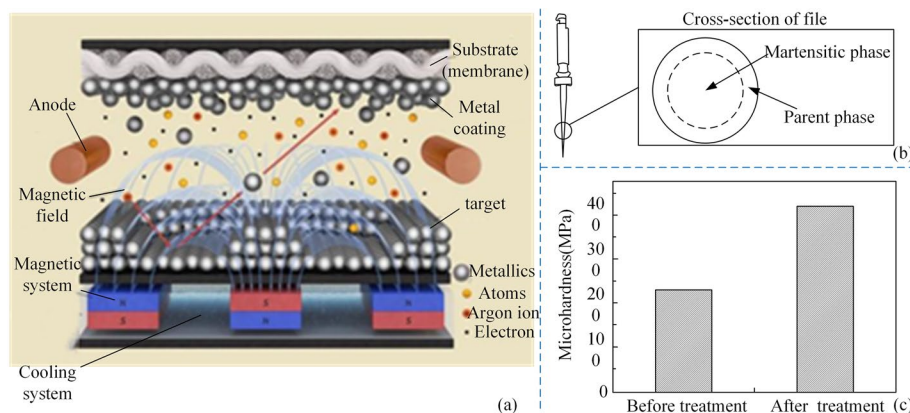

Fig. 5 A surface modification method. Reproduced with permission. Source: CNIPA, www.cnipa.gov.cn. **a** The schematic diagram of the magnetron sputtering principle. **b** Schematic diagram of the cross-section of a nickel-titanium alloy root canal file. **c** Comparison of the hardness of nickel-titanium alloy root canal files after treatment and before treatment

digital display microhardness tester, and the results are shown in Fig. 5(c). It can be seen that the hardness of the root canal files is improved considerably, which means that the cutting efficiency is also improved. High-speed sputtering can substantially increase the deposition rate, but the low utilization of the target material is also a problem that needs to be solved in the future. Table 1 summarizes the machining process and treatment of material-based methods for root canal files.

Geometry

The potential mechanical properties are determined by the geometric design of the root canal file. However, it has been studied extensively because conventional root canal files cannot achieve efficiency and safety at the same time, such as improvements in the centerline [56–59], blade shape [63–66], spiral groove [67–71], tip diameter [61, 62], spatial structure [77–81], and cross-section [98–105] of the root canal files. It aims to enhance the potential mechanical properties of root canal files and optimize the mechanical properties and fatigue resistance.

Special-shape

Root canal files are flat in shape and are prone to jamming due to their low chip removal efficiency. Its handle structure also obstructs the clinicians’ view and reduces the efficiency of preparation. The use of special-shape methods can solve this kind of problem.

Scholars have improved the root canal files’ spatial structure to address the problem that the cutting edge does not fit closely to the root canal wall. For a better cut of root canal walls, Long XP and Long YF invented 3D root canal files [56, 57]. The structure is shown in Fig. 6(a, b). For cleaning a root canal in all directions, Johnson WB proposed multi-curvature root canal files [58] with at least two curvatures located in different planes. Figure 6(c) shows a schematic diagram of the files in operation. Wang Z proposed that the central axis of the working part of the root canal files should be designed as a spatial spiral shape [59], which is better adapted to the root canal’s direction. The structure is schematically shown in Fig. 6(d). A root canal files

Table 1 Overview of improved material methods of root canal files

Material-based	Material objects	Substrate internal materials/ Surface treatment materials	Processes/ methods	Performance	Characteristics	Code
Matrix material	NiTi	MA and AU	CDA	Gradient flexible	GF	CN105852991 [32]
	NiTi	MA M phase MA R phase AU A phase	CDA	Adapt to canal	FR	CN107242911 [33]
	NiTi	MA and AU	HT, Ultrafine crystal process	HCE	WR	CN102743233 [34]
	NiTi	AU	Mechanical process	Different material application	GS	CN206518610 [35]
	Polymer	Stainless steel, NT	3D printing/ mold making	Can be made smaller	GF, IS	WO2020243281 [36]
Surface material	Magnesium alloy	Magnesium and fluorine	Fluorine coating	Safety for the human body	Degradable, IS	CN203677273 [37]
	NiTi	Electrolytic materials	HT, CP	Improve surface performance	WR	US20110159458 [42]
	NiTi	High vacuum atmosphere compounding	Electro-chemical polishing	Good glossy finish	FR	CN111685897 [43]
	NiTi	Polisher	Mechanical polishing	Save manufacturing time	Easy production	CN108788644 [44]
	NiTi	Chemistry	CP	Stabilize passivated oxide layer	FR, GF	US20160024311 [45]
	NiTi	TiZrON	Chemical composite membranes	Inhibits the diffusion of nickel ions	IS	CN105908136 [52]
	N/A	Metal	CDA, Reduced material process	Metal coating	GF	CN112453828 [53]
	NiTi	Fullerenes, NiTi, inorganic	Selective coating	Reduce the friction	IS	CN103096830 [54]
	NiTi	Metal	Magnetron Sputtering	High hardness	HCE	CN104630730 [55]

Materials/Processes: *NiTi* Nickel-titanium, *MA* Martensite, *AU* Austenite, *CDA* Cold drawn Annealed, *HT* Heat treatment, *CP* Chemical polishing

Performance/Characteristics: *GF* Good flexibility, *FR* Fatigue resistance, *WR* Wear resistance, *IS* Improve safety, *HCE* High cutting efficiency, *GS* Good stability

with two edgeless sides has been proposed by Kou WZ to reduce the unnecessary cutting of dentin [60]. Figure 6(e) illustrates how a root canal can only be treated in one lateral or longitudinal direction. William J proposed a guided tip structure [61], as shown in Fig. 6(f), to reduce unnecessary resistance caused by the tip of the root

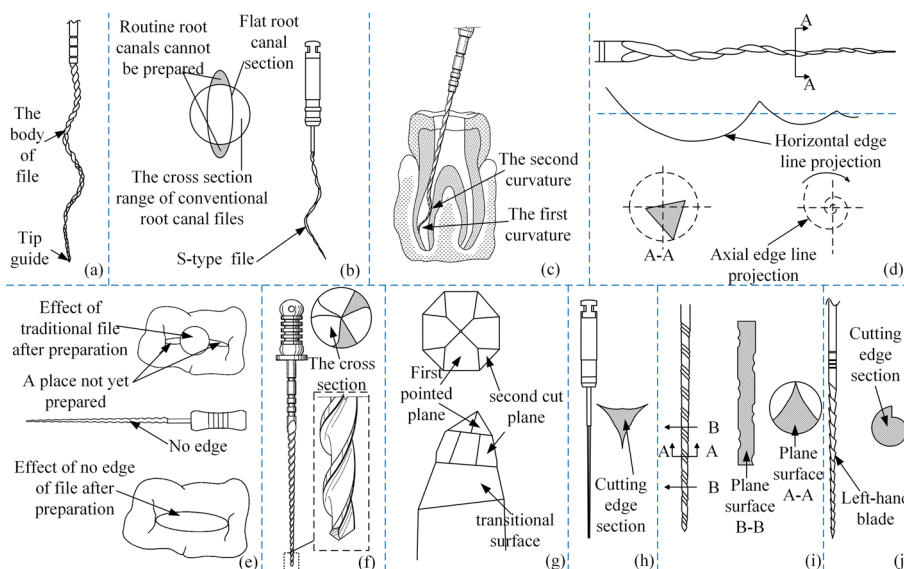

Fig. 6 Irregular root canal files. Reproduced with permission. Source: USPTO, www.uspto.gov; CNIPA, www.cnipa.gov.cn. **a–b** 3D root canal files [56, 57]. **c** Multi-curvature root canal files [58]. **d** A spatial spiral shape [59]. **e** A root canal file with two edgeless sides [60]. **f** A guided tip structure [61]. **g** A first cusp and a second section at the tip of the file [62]. **h** A left-handed pattern [63]. **i** A vertical pattern [64]. **j** Increasing the chip-tolerant space [65]

canal files. Bai LL proposed a first cusp and a second section at the tip of the files [62] to improve guided travel and cleaning efficiency in root canals. The structure of the improved root canal files is shown in Fig. 6(g).

About the root canal wall being embedded with the cutting edge, Long XP and Long YF changed the conventional cutting edge to a left-handed pattern [63] and a vertical pattern [64]. The structure is shown in Fig. 6(h, j). By increasing the chip-tolerant space, as shown in Fig. 6(i), Long XP avoided continuous embedding [65]. Farrag OAS proposed three types of files [66]. The first file's cutting edge is side cutting with pyramidal teeth and ends in a pointed tip. The second type of file has a curved cross-section and a sharpened tip, with pyramidal teeth lining the edges of the curved blade section. The third type of file has a flat debriiding side that tapers to a point, with a series of adjacent 3D pyramids emerging from this surface for removing loose material or in urging already loosened material from a root canal, as shown in Fig. 7(a). Scholars also started from the continuity of cutting edge [67–71], which increased chip space and improved the chip removal function compared to the body of the conventional file. In this type of file, the edges are discontinuous, thus avoiding continuous embedding and making the solid part of the root canal files smaller. As shown in Fig. 7(b–f), it only plays an enlarging role during continuous cutting and can effectively prevent side penetration and the appearance of steps. Researchers have improved the handle structure [72–76] of root canal files in response to the problem of obstructing the line of sight when using root canal files, as shown in Fig. 7(g–k). The curved files make it easier for the dentist to treat patients with restricted openings or molar teeth, avoiding damage to other healthy areas. Table 2 summarizes the advantages and limitations of the special-shape methods for root canal files.

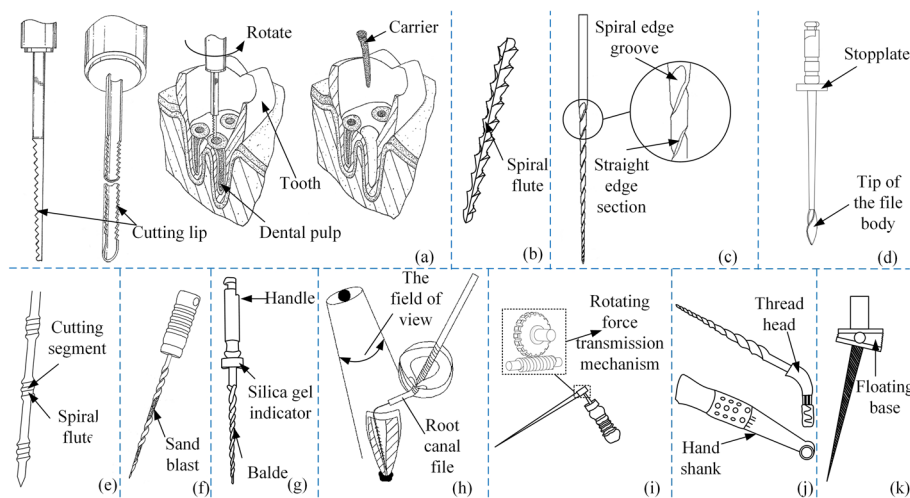

Fig. 7 Discontinuous root canal files. Reproduced with permission. Source: USPTO, www.uspto.gov; CNIPA, www.cnipa.gov.cn. **a** A series of adjacent 3D pyramids [66]. **b–f** Discontinuous cutting edge [67–71]. **g–k** Root canal files for molar teeth [72–76]

Special-structure

There are complex morphological structures and variants in the root canal. However, ordinary root canal files have a single range of preparation and are formed in one piece, making it difficult to clean the small roots within the root canal. In many cases, these tiny branches harbor bacteria and it is difficult to clean them with conventional root canal files. Consequently, many scholars proposed the composite structure method, which not only promotes full chemical action in the root canal but also better conforms to the root canal's shape.

Figure 8(a–c) shows the structures [77–81] of the kinds of files. As the files' volume and use profiles change during use, the root canal is effectively cleaned without excessive widening of the root canal wall. Root canal walls are uniformly cut, which helps keep the root canal system in its original shape. More effective cleaning of flat, oval irregular root canals and root canal isthmus areas. The works of references [82–84] proposed to wind a spiral winding set on the surface of the file's body. According to the reference [82], when the files reach the root tip, rotation in the opposite direction creates a brush that sweeps debris out of the root canal. This is shown in Fig. 8(d). In reference [83], the elastomeric grip has an outer diameter that is slightly wider than an internal diameter of a barrel of a dental instrument whereby on insertion into the barrel it is supported therein only by friction. If the shear force between the files and the root canal increases beyond a predetermined value, the grip will slip in the handpiece barrel and no breakage damage will occur to the files, nor any undesirable damage to the dentine layer. The file structure is schematically shown in Fig. 8(e). In reference [84], besides a spiral winding around the body of the file, a high-pressure spray of metal particles is applied to its surface. A textured surface on the files is used to polish the walls of root canals. Figure 8(f) shows a cross-sectional view of the files in two embodiments in the vertical direction.

Table 2 Overview of special-shape methods of root canal files

Code	Special-shape	Performance	Advantage	Limitation
CN209595930 [56]	3D	SS	GCR	Insufficient strength
CN207400812 [57]	S-shape	SS	GCR	Weak chip removal function
US10136962 [58]	More curvature	SS	LR	No easy access to the inside of the root canal
CN209032679 [59]	Helical shape	SS	GC	Out of alignment with the root canal axis
CN201676027 [60]	Normal	Without two edges	LR	A single type of preparation
EP2140 828 [61]	Small tip	Three spiral grooves	LR	Small contact area affects cutting performance
CN211460595 [62]	Optimized tip	Two special surfaces	GCR	Non-streamline design tends to cause steps
CN203724240 [63]	Vertical cutting pattern	Vertical	NCE	Vertical grain affects chip removal efficiency
CN209933021 [64]	Multiple spiral grooves	Many	GCR	Too many spiral grooves affect the strength of the files
CN203943750 [65]	N/A	Left-hand blade	NCE	Left-handed blades are not versatile for users
US11083539 [66]	Tubular	Zigzag structure	NCE	Large size and inconvenient operation
CN109498186 [67]	Composite cutting edges	Discontinuous	NCE	The spiral groove is in the opposite direction of the cutting edge
CN213552491 [68]	Multi-pronged cone	Spiral	GCR	Not easy to control when rotating at a high speed
CN211884087 [69]	Smooth	None	IS	No cutting edge leads to poor cleaning ability
US20100119990 [70]	Interrupted shapes	Discontinuous	NCE	Continuously interrupting spiral grooves affect chip removal
EP3170471 [71]	Spiral wound wire sets	Discontinuous	NCE	Spiral wound wire sets may not be strong enough to bond with the substrate
CN206518609 [72]	Improved handle	Change to the universal handle	GV	Difficult to expand the scope of use
CN211049650 [73]	Improved handle	Extended handle	GV, GVI	The handle is too long to affect the operation
CN206910406 [74]	Improved handle and blade	Change of angle	GV	Unstable bending part
CN205339178 [75]	Improved handle	The changed direction of the handle	GV, GVI	Difficult to disassemble
CN108542513 [76]	Improved handle	Change to floating seat	GC, GV	Unstable force transmission during use

GCR Good chip removal, SS Space spiral, LR Low resistance, GC Good convenience, NCE No continuous embedding, IS Improve safety, GV Good versatility, GVI Good visibility

The composite structure makes it easier to carry the chemical irrigation agent into the root canal, which helps clean the necrotic debris and bacteria from the inner wall of the root canal and allows the solution to have the best dissolving properties on the tissue. The advantage of these root canal files is that they offer a greater cleaning range than conventional root canal files and better conform to root canal alignments,

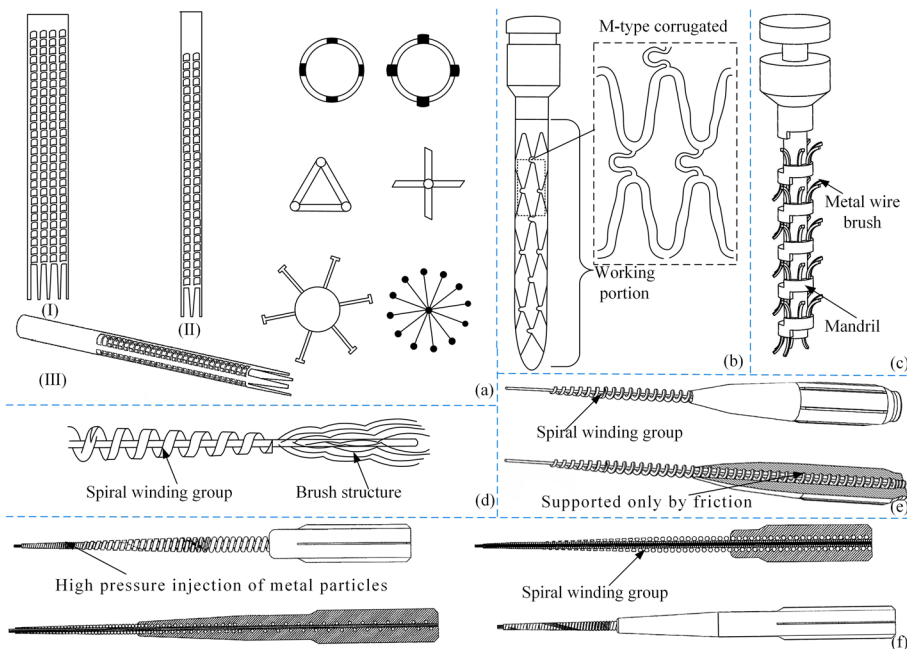

Fig. 8 Self-adjusting root canal files. Reproduced with permission. Source: USPTO, www.uspto.gov; CNIPA, www.cnipa.gov.cn. **a-c** Use of variable profiles root canal files [77–81]. **d** Brush. **e-f** Spiral wound root canal files [82–84]

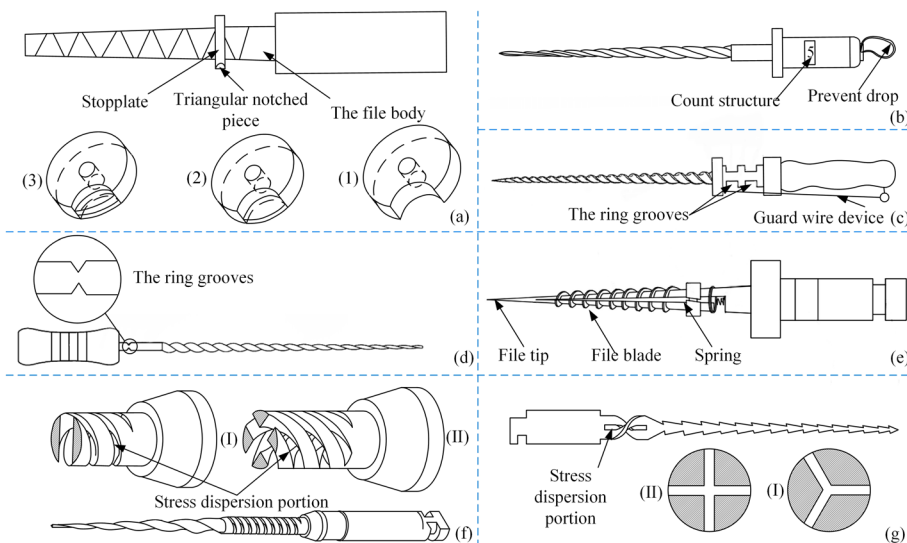

Fig. 9 Prevent fracture of root canal files. Reproduced with permission. Source: USPTO, www.uspto.gov; CNIPA, www.cnipa.gov.cn. **a-b** Counting type root canal files [85–87]. **c-g** Preventing stress concentration in root canal files [88–92]

but the disadvantage is that they are not strong enough. Over-preparation may result in thinning of the root canal wall, but there is a risk of inadequate preparation and residual inflammatory material, leading to secondary recurrence.

Fractures of root canal files are classified into fatigue fractures due to the excessive use and stress concentration fractures due to structural problems. Li M and Zhang DB

proposed root canal files [85–87] that could count the number of times they were used, as shown in Fig. 9(a, b). Manual counting and electronic counting are the two counting structures. A controlled method [88–90] was proposed in the pieces of reference for locating root canal files fractures caused by stress concentration. When excessive torque or repeated use causes metal fatigue, the files will break at their setting to prevent fracture in the root canal. The structure of this type of root canal file is shown in Fig. 9(c–e), respectively. It was proposed to add a “stress dispersion part” [91, 92] between the conventional files and the handle in the reference, as shown in Fig. 9(f–g). Table 3 summarizes the methods of the root canal files based on the structure.

Special-section

Due to the symmetrical cross-section of the file body, conventional root canal files are inflexible and have difficulty following the tendency of the root canal to enter the tip. A fracture is likely to happen when the root canal is severely flexed. The asymmetric cross-section, or eccentric section, is a newly proposed design. It has a serpentine wave-like motion and points in contact with the root canal wall. The asymmetric cross-sectional design gives the root canal files more space to accommodate debris, facilitating debris removal, and its serpentine motion makes it easier to access the root tip. It has also been found that the eccentric cross-sectional design reduces the torque exerted on the instruments, which improves their preparation efficiency and facilitates root canal formation

Table 3 Overview of special-structure methods of root canal files

Code	Special-structure	Method	Performance	Characteristics
US20110081623 [77]	STF	Mesh structure	The realization of different shapes and sizes	IS, HA
CN208114663 [78]	STS	M- and inverted M-wave	Adaptation of root canals	Uniform cutting
CN110497163 [79] CN110693615 [80]	STS	Brushed metal	Composite embryo process	GCR
WO2018002951 [81]	STS	Flexible filament arrangement	Basket shape	IS
US20140045142 [82]	STS	SWW	Brush sweep	GCR
US20110212413 [83]	STS	SWW and sandblasted	Sliding between files body and handle	IS
US9585731 [84]	STS	SWW with metal particles	With polishing function	GCR, HCE
CN209107620 [85]	STH	Counter	Simple counting	Easy to observe the number of uses
CN108542512 [86] CN108433831 [87]	STH	Counter	Visual counting	Direct observation of the number of uses
CN202437374 [88] CN209004247 [89]	STF	Setting recess	Ring grooves	IS, RSC
CN113081324 [90]	STF	SRS	Ring grooves	IS, RSC
EP3597141 [91]	STF	SRS	Spiral springs	IS, RSC
US20160128800 [92]	STF	SRS	Horizontal penetration port	IS, RSC

Special-structure/Method: *STF* Structure of the files, *STS* Structure of surface, *STH* Structure of Handle, *SRS* Stress relief section, *SWW* Spiral wound wire

Performance/Characteristics: *IS* Improve safety, *HA* Highly adaptable, *GCR* Good chip removal, *HCE* High cutting efficiency, *RSC* Reduction of stress concentrations

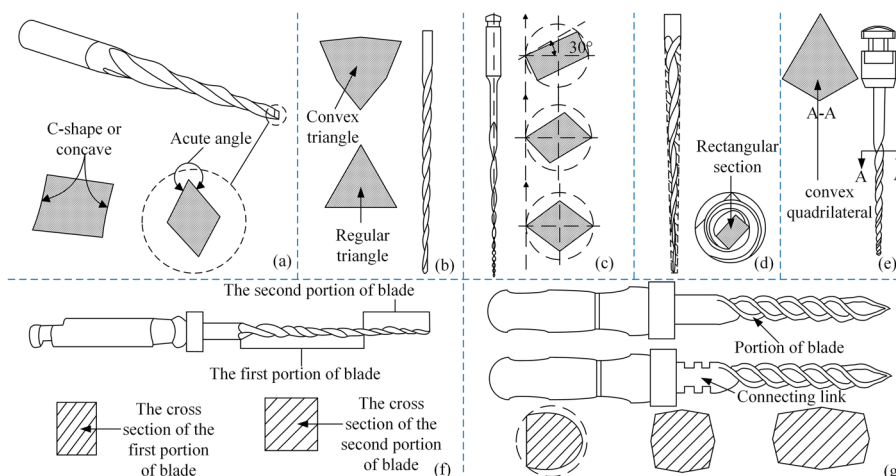

Fig. 10 Special-section root canal files. Reproduced with permission. Source: USPTO, www.uspto.gov; CNIPA, www.cnipa.gov.cn. **a** A parallelogram cross-section [93]. **b** A convex triangular design [94]. **c** A non-isometric cross-section [95]. **d** A rectangle-shaped [96]. **e** A convex quadrilateral [97]. **f** A rectangular cross-section and a square cross-section [98]. **g** A quadrilateral cross-section [99]

when preparing narrow curved root canals. An important aspect of the fatigue resistance of root canal files is their cross-sectional design, the continuous improvement of which will optimize fatigue resistance.

A parallelogram cross-section [93] was proposed by Shotton V, which has an acute angle and an asymmetric rotation axis. Its center of mass is not on the axis of rotation, which can produce a larger scraping range. Figure 10(a) shows the schematic diagram of the file's structure with the cross-section of the body at different positions. A convex triangular design was proposed by Long XP to improve the fatigue strength of root canal files in the circumferential and axial directions [94]. Figure 10(b) shows a schematic diagram of the structure of the files. Wang Z proposed root canal files with a non-isometric cross-section [95]. As shown in Fig. 10(c). Due to the difference in axial dimensions, the bending deformation capacity is poor in the direction of the long axis of the cross-section. However, it has a good deformation ability in the short-axis direction. Thus, flexibility is improved while strength is maintained. Zhong S used integral machining and molding, and the cross-sectional shape [96] and the center of rotation of the file bodies were designed eccentrically. Figure 10(d) shows a cross-section of the files with one of the implementation forms. A rectangle-shaped file cross-section only has two adjacent corners on the cutting boundary when it is designed as a rectangle. The force on the root canal files is greatly reduced. Yue B proposed that the cross-section [97] is a convex quadrilateral, where three angles are obtuse or right angles and the other angle is acute. As in Fig. 10(e), the files allow overcutting of the dentin. Liu S proposed root canal files with a double-edged section [98], where the first edge was machined from a cone with a rectangular cross-section and the second edge was machined from a cone with a square cross-section. Figure 10(f) shows a schematic diagram of the shape of the files with enhanced chip evacuation. Liu S then proposed that the files have a quadrilateral cross-section [99–101], the convex ribs project outward and the edge part is twisted by the cone. Using this method, the root canal files automatically conform to the root canal

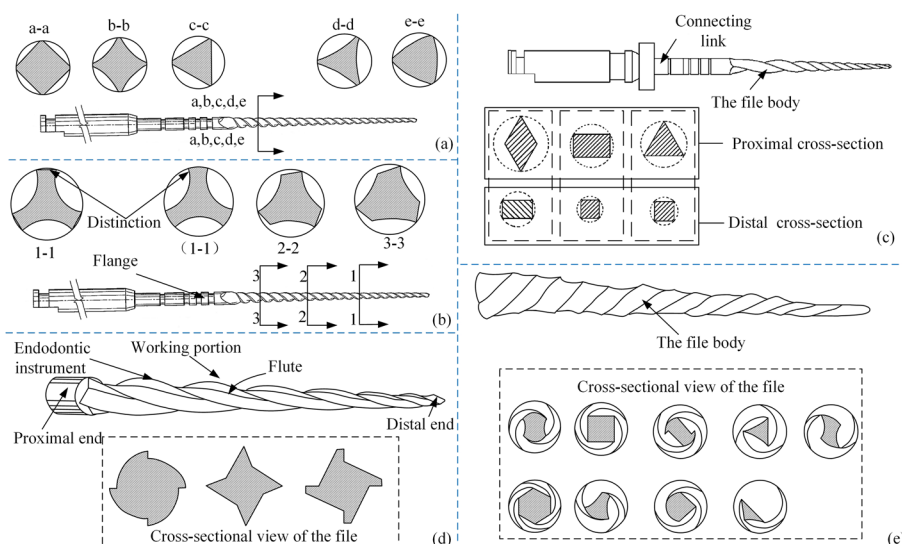

Fig. 11 Special-section root canal files. Reproduced with permission. Source: USPTO, www.uspto.gov; CNIPA, www.cnipa.gov.cn. **a** The cross-sectional shape of the root canal files in the reference [102]. **b** Schematic diagram of the cross-section of the root canal files [103] in different positions. **c** Proximal cross-sections and distal cross-sections in the reference [104]. **d** Cross-sectional view of the files in the reference [105]. **e** Cross-sectional view of the files in the reference [106]

shape, which facilitates its entry and prevents the occurrence of lateral penetration. Figure 10(g) depicts the structure of the files and the cross-section of the edge.

Besides the cases described above, there are also ways to set different cross-sectional shapes according to different needs. Figure 11(a) illustrates the cross-sectional shape [102] of the root canal files in the reference, which ensures flexibility and strength. A concave helical groove [103] with continuous intervals was proposed by Jaunberzins A for the handle section. Additionally, it increases flexibility, reduces torsional resistance, and extends the prepared length. Figure 11(b) shows a schematic diagram of the structure of the files. Zhou L proposed that the cross-section [104] of the files gets smaller as it gets closer to the distal end. There is a difference in cross-sectional shape between the distal and proximal ends of the files. And in any two sections, the ratio of the area of the section near the proximal end to the area of its outer circle is not greater than the ratio of the area of the section near the far end to the area of its outer circle. As shown in Fig. 11(c), the strength of the middle section of the root canal files and the toughness of the distal end is ensured. William B proposed a polygon cross-section [105] at the proximal end of the files, which gradually becomes a square at the distal end. The cut angle of the files is achieved by rotating it in a positive direction, whereas the scraping angle is achieved by turning it in a negative direction. Figure 11(d) shows a schematic cross-sectional view of the files and their various embodiments. McSpadden JT proposed multi-tapered root canal files [106]. There are at least two grooves on the body of the file, which are, respectively, thinned along with the root canal files according to a predetermined taper function to form different sections. Torque loading should be reduced and the tendency to screw into the canal should be reduced. Figure 11(e) shows a schematic diagram of the profiles of the files and partial transverse cross-section views of additional alternative embodiments of a multi-tapered endodontic instrument. This kind of

Table 4 Overview of special-section methods of root canal files

Special-section shape	Method	Performance	Code	Illustrations
Parallelogram	Asymmetrical design	LCS, GCR	US20150216624 [93]	
Convex triangle	Adaptation to different patients	Circumferential HCE, axial FR	CN204446150 [94]	
Non-isometric section	Non-isometric section	GF	CN206044757 [95]	
Eccentric design	Asymmetrical design	Non-breakable, IS	CN206910405 [96]	
Convex quadrilateral	Can overcut	LCS	CN209884369 [97]	
Rectangular	Includes two cutting edges	GCR, IS	CN206995351 [98]	
Quadrilateral Convexity	With convex ribs	HA, GF	CN204446152 [99] CN204446154 [100] CN204446155 [101]	
Irregular shape	Inner joint round	FR, IS	US20170135786 [102]	
Irregular shape	Continuous interrupted concave spiral grooves	Variable and flexible length, LCS	US20100297578 [103]	
Gradual reduction	Different section shapes	HA, GF, LCS	CN209611357 [104]	
Concave polygon	Different rotation directions correspond to different functions	GV, HCE, IS	US20100040994 [105]	
Multi-conical	According to different taper functions	GCR, HCE	US20100255442 [106]	

LCS Large cleaning space, GCR Good chip removal, HCE High cutting efficiency, FR Fatigue resistance, GF Good flexibility, IS Improve safety, HA Highly adaptable, GV Good versatility

file meets the different performance priorities of the proximal and distal ends by setting polygons of different shapes at the proximal and distal ends of the body of the file. Under the premise of ensuring cutting efficiency, the body of the file can take into account the

chip removal ability and strength requirements. Table 4 summarizes the special-section shape and their illustrations.

Additional function

Clinicians and patients look for safety and cleaning ability in root canal files when they use them in clinical settings. However, even with root canal files, problems, such as instrument separation, accidental falling off, secondary infection of the dental pulp, inadequate preparation, or over-preparation, may still occur. Root canal files perform insufficiently, which is obvious from their single function. Insufficiently performing root canal files cause these problems. The methods of adding additional functions have been proposed by scholars as a means of solving these problems. The paper categorizes them into three types: anti-fall methods, anti-infection methods, and anti-error methods.

Anti-fall

Clinically, root canal files are used in a humid oral environment, which is susceptible to accidental falls. Two types of accidental falls of root canal files are caused by saliva lubrication and loose connections between the file’s body and handle. When used in clinical settings, the root canal files are very close to the respiratory tract, throat, and other tissues. Accidental falling off will easily cause medical accidents. Recently, several methods have been developed to prevent falling off.

Hao ZY and Chi HY proposed files with a rope threading hole [107, 108], as shown in Fig. 12(a, b). Luo WC proposed a file equipped with a magnetic bracelet [109]. Figure 12(d, e) shows the structure of the magnetic bracelet. To prevent falling, the handle of the root canal files can work with the magnetic bracelet, but the direction of the resultant force of magnetic force and external force is somewhat difficult to control. A root canal file with a handheld part was proposed by Wang LX to solve the issue of poor holding stability [110]. The structure is shown in Fig. 12(c). But it is bulky and inconvenient to hold.

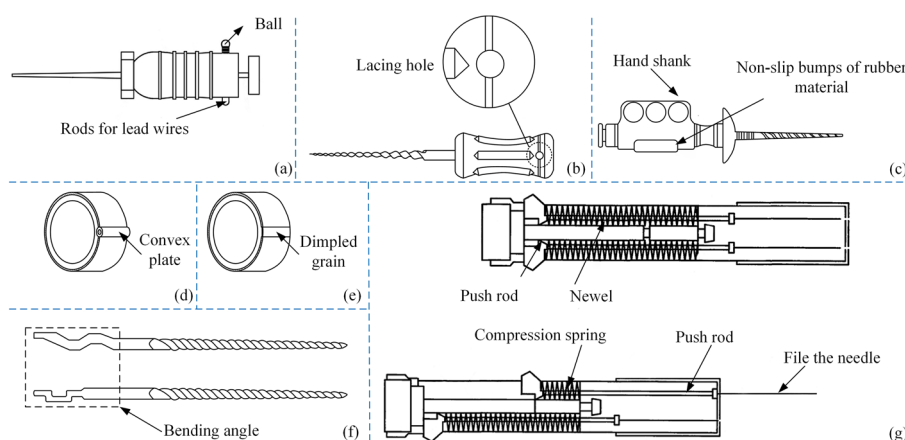

Fig. 12 Anti-fall root canal files. Reproduced with permission. Source: USPTO, www.uspto.gov; CNIPA, www.cnipa.gov.cn. **a-b** The files with a rope threading hole [107, 108]. **c** Root canal files with a stable handle [110]. **d-e** Magnetic bracelets prevent falling off [109]. **f** A bending structure prevents falling off [111]. **g** With a special cylindrical structure [112]

As shown in Fig. 12(f), Sun QX proposed a bending structure [111] for the loose part of the body of the file and handle. This could solve the problem of sliding between the root canal files and handle. Zheng YX proposed the files with the structure [112] shown in Fig. 12(g). The end of the body of the file is provided with a cylindrical body, which is provided with some push rods for fixing the file's needle, and the push rods are, respectively, sleeved with a compression spring. The structure can select files of different specifications according to needs and can also adjust the working length of the files. The special cylindrical structure can also prevent the connecting part between the file's body and the handle from loosening. In Fig. 12(g), the left side is the schematic diagram of the root canal files pressing out the body of the file.

Anti-infection

During root canal therapy, pulp infections are common. Dentin fragments and root canal files that are accidentally broken in the root canal can cause pulp infection. At present, there are solutions, such as combining ultrasonic technology [96] or disinfection light source [101] with traditional mechanical root canal files, combining chemical flushing with mechanical preparation [97–100], and special tip structure [103, 104] for broken files. It is no longer simply a matter of cleaning up the necrotic pulp in a root canal, but the process of preparing a root canal is becoming simpler and safer.

Ramos CAS combined ultrasonic technology [113] with root canal files to help destroy necrotic tissue due to the difficulty of removing debris, the structure of which is illustrated in Fig. 13(a). As shown in Fig. 13(b–e), scholars proposed applying the flushing function [114–117] to the root canal files to remove debris. Sterilization and disinfection follow the cleaning of the dentin. To better restore the prepared root canal, light-based root canal files were proposed in the reference [118]. It can emit light of one or more wavelengths, which can realize a variety of therapeutic benefits, for example, disinfection, tissue regeneration, reconstruction of vascular tissue, and reduction of

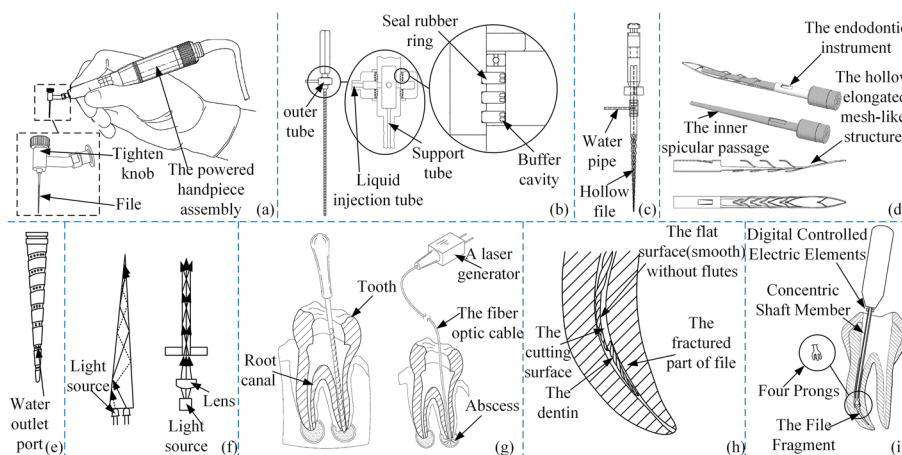

Fig. 13 Anti-infection root canal files. Reproduced with permission. Source: USPTO, www.uspto.gov; CNIPA, www.cnipa.gov.cn. **a** Root canal files with ultrasound function [113]. **b–e** Root canal files with flushing function [114–117]. **f** Root canal files with light anti-inflammatory function [118]. **g** Root canal files with laser anti-inflammatory function [119]. **h** Can bypass fractured root canal files [120]. **i** Can clamp fractured root canal files [121]

inflammation or pain. Figure 13(f) shows a schematic diagram of two embodiments of the files. A plurality of files [119] is provided and each file is insertable into a root canal. The fiber optic cable is insertable into the root canal to communicate the laser light onto an abscess for eliminating the abscess without conventional surgical intervention, as shown in Fig. 13(g).

For accidental fracture of stuck files fragments. Radwan S proposed files [120] that can bypass the fractured part. As shown in Fig. 13(h). Later, he proposed a champing-type [121] root canal file that can remove the fractured files. These root canal files can help complete a complete root canal therapy without the influence of fractured files, as shown in Fig. 13(i)

Anti-error

The most common cause of pulp failure in root canal therapy is insufficient or excessive preparation of the root canals. Often, these complications occur as a result of a poor understanding of root canal length before the operation, so it is especially important to measure root canal length accurately. An apical locator is a traditional tool for measuring the working length of the root canal. During operation, large errors are often caused by cursor movement or personnel errors. Measurement steps are not only cumbersome but also inaccurate and time consuming. In addition, estimating the length of a root canal may lead to over-preparation or under-preparation due to mistake operation.

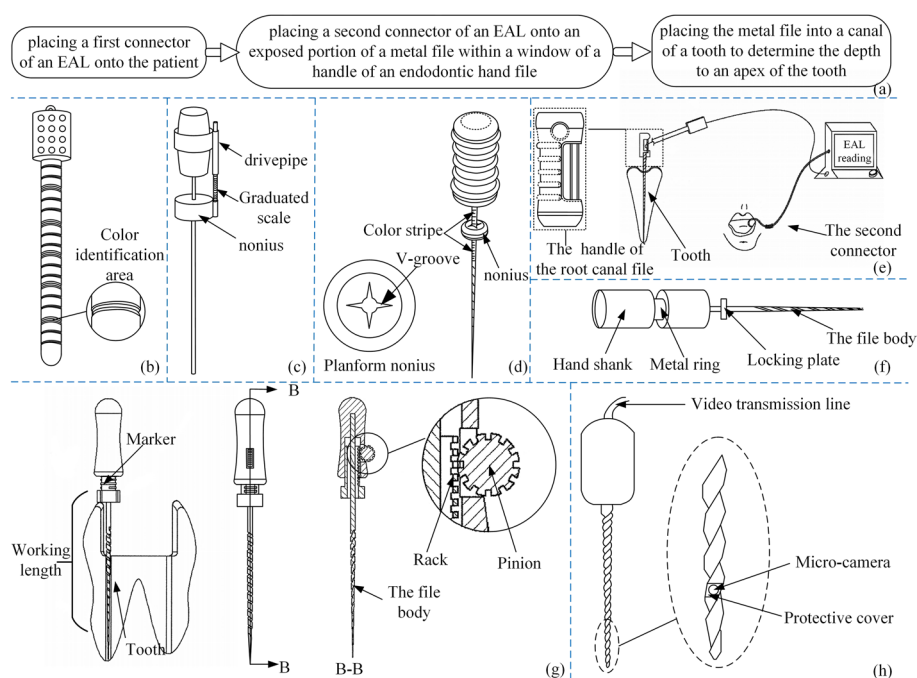

Fig. 14 Effective preparation of root canal files. Reproduced with permission. Source: USPTO, www.uspto.gov; CNIPA, www.cnipa.gov.cn. **a** Process of using the electronic apical locator. **B–d** Root canal files for measuring root canal length [122–124]. **e** Root canal files with exposed window [125, 126]. **f** Structure to prevent disturbance [127]. **g** Structures limiting the working length of root canal files [128]. **h** Microscope working schematic [129]

Several methods to prevent error preparation have been proposed in recent years in light of these problems.

The references [122–124] provided root canal files for measuring root canal length, and Fig. 14(b–d) illustrates its structure. By setting an exposure window at the handle of the root canal files, Bagheri MJ attempted to overcome the problem of the traditional electronic apical locator sliding [125] when attached to the body of the files. The window structure is shown in Fig. 14(e). The snap of the electronic apical locator can be connected to the metal handle in the window exposure. These steps in Fig. 14(a) are performed in the root canal therapy of a patient. A solution [126] proposed by Du Y is to integrate the aluminum wire of the electronic apical locator with the metal of the handle so that the process of measuring root canal length does not involve repeated clamping and removal. Additionally, the measuring instrument collet can be avoided from affecting the field of vision and operation. Cai proposed a metal ring [127] fixed to the handle to solve the interference problem between the clip and the stopper. Figure 14(f) shows the structural diagram of the files. Curry AD proposed a method to limit the length of root canal files into root canal [128]: Root canal files have an adjustment scale and a nonius on the body. Once inserted into the root canal, the washer should be fixed to the tooth surface, which is shown in Fig. 14(g). Zhang XR proposed setting a micro camera at the end of the files away from the handle and embedding a video transmission line in the files [129], as shown in Fig. 14(h). Through the transmission line, images captured in real time in the root canal can be transmitted to the external display device, so that you can observe the root canal in real time. The relevant files and their improved methods are summarized in Table 5.

Discussion

As shown in Fig. 15, we can see that the number of patents for root canal files has increased each year since the first patent for the root canal file, US04028810, was filed in 1975. This proves that in recent years there has still been a lot of researches into how to improve the performance of root canal files. By reviewing the paper, the development of root canal files in the last decade has been dominated by geometric designs. The geometric design [130, 131] influences the movement of the root canal files and determines the forces applied to files in the root canal. Further, due to the advantages of composite structures, such as hollow structures, compressibility, the ability to mount specific flushing devices, and continuous chemical preparation alongside mechanical preparation, research hotspots have shifted from the cross-section of root canal files to open composite structures. However, there are some limitations to the preparation of special root canals. Therefore, the application of the correct instrumentation in combination with the shape of the root canal can improve the shaping and cleaning ability [132] and reduce complications. Figure 15 shows when anti-infection methods began to appear in large numbers, indicating that patients are taking the safety of root canal treatment more seriously. In the future, anti-infection methods will be a hot new research topic.

However, as the number of ways to improve the performance of root canal files has increased, the performance of root canal files has become more and more sophisticated. Several studies have therefore investigated the differences from several perspectives [133], finding differences in design, phase transformation temperatures, and mechanical

Table 5 Overview of additional function methods of root canal files

Additional function	Method	Performance	Advantage	Code
Anti-fall	Stringing holes	Can be taken out by a string	IS	CN202477881 [107] CN214414938 [108]
	Magnetic bracelet	Can magnetically absorb files	IS	CN204890207 [109]
	Non-slip bumps	Increased friction with fingers	GC, GS	CN209899615 [110]
	Bent section	Increased stability with the handle	GS	CN203790060 [111]
	Cartridge	Addition of different root canal files	GC, GV	CN203564347 [112]
Anti-infection	Ultrasound technology	Activate chemicals	GCR	US20160022377 [113]
	Support tubes	Facilitate fluid injection	GCR	CN212089798 [114]
	Hollow files body	irrigate while treating	GCR	CN211796958 [115]
	Flushing equipment	Hollow files and inner specular passage	GCR	WO2021144465 [116]
	Several holes in the outer surface	Clean and transport dirt	GCR	CN208989188 [117]
	Sterilization unit	Reduce inflammation or pain	HTP	WO2018009864 [118]
	Laser generator	Eliminates the abscess	HTP	US20210244499 [119]
	Flat surface	Can bypass fractured files	IS, GF	WO2021186224 [120]
Anti-error	Prongs	Can remove the fractured files	IS, GC	US10813719 [121]
	MD	Different colored marking zones	IS	CN207545234 [122]
	MD	Nonius	IS	CN206403877 [123]
	MD	Improved nonius	IS, GS	CN205279948 [124]
	Exposure Window	Connection to electronic apical locator	AM, GC	US20190125508 [125]
	Setting up a one-piece structure	Connect the metal wire to the handle	AM, GC	CN206381250 [126]
	Metal rings	Fixed connection to files body	GS, GC	CN206151607 [127]
	Nonius	Nonius can be fixed with different lengths	IS, GS	US20110300506 [128]
Miniature camera	Observation of the inside of the root canal	IS, GVI	CN205626145 [129]	

MD Measuring device, IS Improve safety, GS Good stability, GV Good versatility, GCR Good chip removal, HTP Has therapeutic properties, GF Good flexibility, GC Good convenience, GS Good stability, GVI Good visibility, AM Accuracy measurement

behavior of instruments. The low-cyclic fatigue resistance of counterfeit instruments makes them unsafe systems. To compare the performance of different root canal files in vivo and in vitro experimental studies, multimethod assessments [134] can be considered one of the main advantages of current research. This methodological approach allows for a more comprehensive assessment regarding the properties of the tested instruments, as it avoids “knowledge compartmentalization” a phenomenon in which knowledge structures about a specific domain are composed of several separate parts [131]. Understanding these characteristics may help clinicians make decisions regarding which instrument to choose for a particular clinical situation.

Although we have now improved the performance of root canal files, there are more factors affecting root canal therapy than just the performance of the files. As mentioned

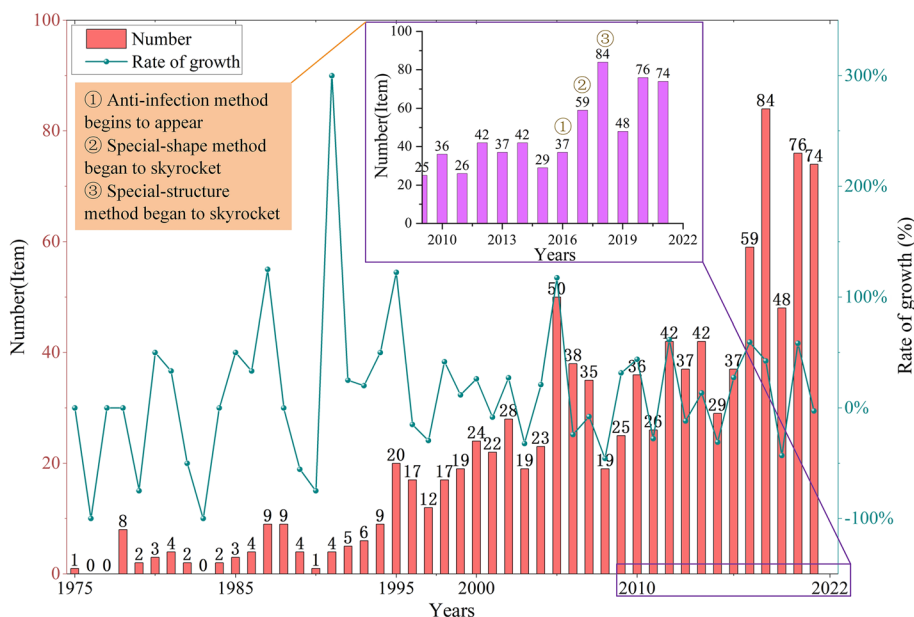

Fig. 15 The growing trend of root canal files

above, the experience of the clinician and the complexity of the root canal affect the success rate. The same root canal file used by different clinicians may give different results for root canal therapy. It may be that experienced clinicians have a better understanding of what kind of root canal file and what form of motion (reciprocation or OTR) is appropriate for the root canal. Root canal therapy capacity, working length variation, mid-axis offset, bending variation, root canal therapy time, and success rate all vary with different file motions. It is important to study the ability of root canal therapy and shaping with different file motions (reciprocation or OTR). Reciprocating motions can reduce the formation of dentin cracks to some extent in terms of safety compared to conventional rotary motions [135–137], but this advantage needs to be based on the selection of a suitable model according to the size of the root canal. Whereas the introduction of apical debris is closely related to both the motion pattern and the cross-sectional design of the instrument [138–140], debris removal is facilitated if a large amount of flushing fluid is used during root canal therapy [141]. Reciprocating Nitinol files are made from especially tensile machined and heat-treated M-wires, which are significantly more resistant to cyclic fatigue behavior and wear than other Nitinol instruments [142, 143]. In terms of microbial clearance, when applying reciprocating motion for root canal therapy, although the mechanical preparation time is significantly reduced, the flushing time should be longer than when using a continuous rotary motion system for root canal therapy due to the need to flush with an adequate amount of flushing fluid [144]. The reciprocating motion has the least change in working length and root canal curvature in terms of natural root canal morphology maintenance [145]. The two main directions affecting working length variation are the curvature of the root canal and the adjustment of the coronal access [146], and the more curved the root canal, the more pronounced the straightening effect of the adjustment of the coronal access. In terms of

efficiency, the application of a single file reciprocating motion root canal therapy system avoids frequent instrument changes and, together with its greater dentin-cutting capacity, improves the efficiency of root canal therapy [147, 148]. And the OTR motion, Optimum Torque Reversal, is a torque sensitive, round-trip motion mode. OTR motion contributes to the release of spin-in forces compared to conventional rotational motion, and continuous rotation generated notably higher peak torque values than OTR motion [149]. The OTR movement reduces the torque and wedge forces during the crown-down preparation phase of the crown-down method and the apical preparation phase of the single-length method. The number of instrument separations can therefore be reduced.

This paper reviewed improved methods of root canal files. Figure 16(a, b) shows the percentage of root canal patents that is classified by the improved methods. According to the patents selected for this paper, the additional function methods account for the largest proportion of the three major classifications of root canal archives, at 40%. From Fig. 16(b), it can be found that among the eight subcategories of improvement methods, the special-shape methods accounted for the highest percentage at 24.4%, while the anti-fall methods and the matrix material methods accounted for the lowest percentage at 7.0%. The patents appearing in the paper are ordered in Fig. 16(c) by improved methods and time of appearance. The specific improvements to each root canal file are also shown in Fig. 16(c). The key techniques and features are represented in Table 6.

Future trends

Material

The methods for improving the performance of root canal files proposed in this paper pose several problems. Materials for root canal files should be developed to solve the problems encountered in the clinical use of root canal files. Considering the limitations

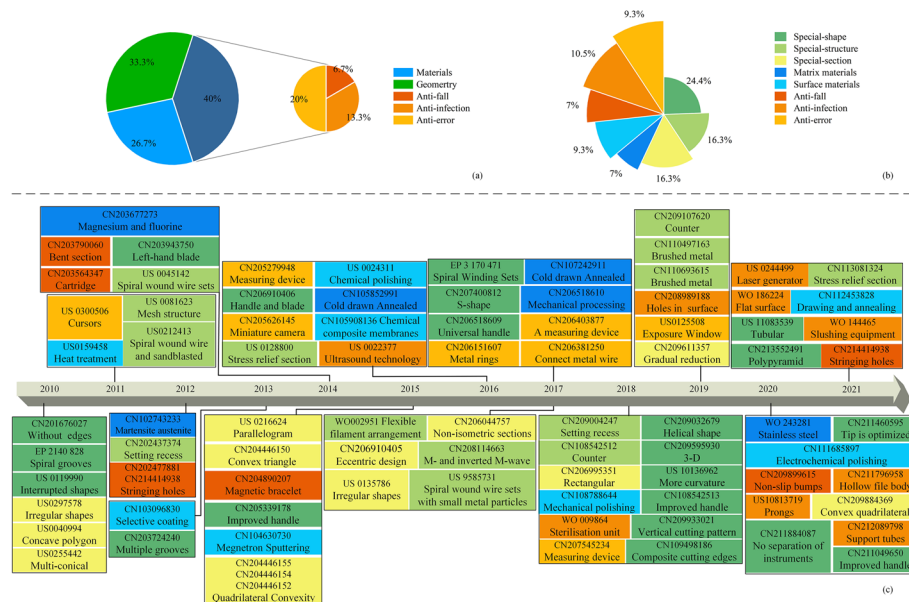

Fig. 16 The patents of this paper. **a–b** Improvement method classification percentage. **c** Patent numbers of root canal files appearing in the paper

Table 6 Overview of three improved methods of root canal files

Improvement type	Method	Key technology	Advantage	Limitation
Material	Matrix	Ultrafine crystal Heat treatment 3D printing	Flexibility Anti-fatigue	Tedious process steps High manufacturing cost
	Surface	Polishing Magnetron sputtering process Coating Technology	Corrosion resistance Inhibition of ion precipitation	Unstable surface coating Low utilization of target material
Geometry	Special-shape	Improvement of internal force/external force Geometric theory	Large preparation space Adaptation of root canal alignment	Inadequate cleaning strength Unstable files structure
	Special-structure	Composite structure theory Stress theory	Easier to carry the chemical irrigation agent into the root canal Prevention of stress concentration	Debris tends to get stuck in the root canal files Weak chip removal function
	Special-section	Full use of shape and structure information Eccentric section design theory	Large chip space Easier access to the root apex	Manufacturing complexity Eccentric structure is easy to lose control
Function	Anti-fall	Structural Design Composite principle	Good grip stability Easy replacement of root canal files	Bulky and heavy Easily stained with dirt
	Anti-infection	Ultrasound Technology Optical therapy technology	Easy to clean dentin Treatment of root canals and endodontics	Expensive to manufacture Difficult to operate
	Anti-error	Use of special structures Micro Photography	No apical perforation Security Ability to measure root canal length	Cannot precisely determine root canal depth The parts are small and inconvenient to operate

of the material, it is possible to study experimentally how to instrument fatigue fracture that occurs during root canal therapy. According to the research results, find alternative materials, such as graphene [150]. Because graphene shows good toughness and high flexural strength, it can adsorb and desorption various atoms and molecules, and has biocompatibility and stability. As part of the root canal therapy process, it can serve as a cleaning and sterilization agent. By using graphene as a base material or surface treatment material, i.e., a highly thermally conductive graphite film, the mechanical properties of the root canal file will be greatly improved. Alternatively, inorganic non-metallic materials are used as the matrix materials for root canal files, such as ceramic materials [151], or medical materials, such as medical-grade Nitinol powder [152]. Vigorous development of medical additive manufacturing technology, breakthrough medical grade titanium powder and nickel-titanium alloy powder and other key raw material constraints, can be a new idea in the manufacture of root canal files. Three-dimensional (3D) printing technology [153] is driving changes in the medical and health care industry, and titanium and titanium alloys [154], as biomedical materials with excellent performance are developing at an alarming rate. The combination of the two will help push personalized medicine to shine. Or making composite materials [155], such as preparing antibacterial materials by polymer polymerization, surface functionalization, and derivatization, and

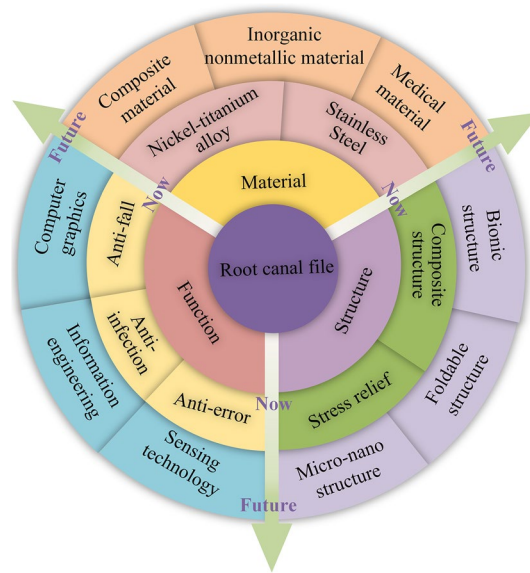

Fig. 17 Future directions of root canal files and future root canal therapy procedures

coating biomimetic micro nanostructures with bactericidal function. To prevent instrument separation, change the surface morphology and structure through physical methods. These future directions of materials are shown in Fig. 17.

Structure

The mechanical properties are influenced by the structure of the root canal file. Three future trends in the structure were discussed in this section. Bionic structures [156, 157] are one of them. As bionic technology keeps evolving, through the design morphology under the biological incentive mode and integration of multi-disciplinary knowledge to learn, simulate, and copy the function, behavior, or structure of organisms, to develop the root canal files with bionic structure. These methods can improve the debris removal ability and cutting effect of root canal files. For example, the tongue of the pangolin [158] can clean out anthills quickly and accurately without causing harm to the anthills, and its method of cleaning out anthills is similar to that of root canal therapy and is worth learning from. The second is the foldable structure [159]. It has a unique space-occupying volume. To introduce a foldable structure that can remove the necrotic pulp without over-preparing the root canal, thereby ensuring the maximum retention of the affected teeth. Finally, we can also start with the size of the structure and introduce a micro nanostructure [160]. Root canal files can be converted into micro nanorobots to realize minimally invasive treatment, remove the necrotic dental pulp, and eliminate bacteria. After you input the digital root canal therapy information, the robot will select the most suitable surgical scheme in the database for this kind of root canal. Automated preparation can replace manual operation completely. These structures are shown in Fig. 17.

Function

In the future, more functions will be added to root canal files to simplify the treatment. Given the current problems encountered with the clinical use of root canal files, this section proposed the following aspects of future functions. For example, the micro-display will be created inside the root canal, by using 3D display technology [161], and the clinicians can observe the progress of root canal therapy in real time to determine the next step needed. With sensing technology [162] and computer graphics technology [163], it is possible to perform under-preparation detection, over-preparation detection, collision detection, and detection of whether the root tip is reached, allowing for safer and more complete preparations. As computer and artificial intelligence technologies [164] continue to develop, a large number of root canal therapy cases have been compiled on the Internet, which can provide more comprehensive information on the problems of root canal therapy. So, before formal root canal therapy, the root canal model can be generated based on the patient's real dentition. Clinicians can then select the appropriate root canal files based on the patient's 3D root canal model with biomechanical properties and perform root canal therapy. When faced with this type of root canal, the large number of root canal models will help clinicians choose the right root canal files. A trial preparation with root canal files will be conducted based on the virtual root canal model. The sensor on the root canal files will examine the problems encountered. If the files are not suitable for preparing that type of root canal at this time, the clinician can replace them in advance without causing a break during clinical use. It is possible to anticipate the risk and make timely adjustments. In Fig. 17 you can see some general directions based on the additional functional methods.

Conclusion

In this paper, we analyze the problems encountered in the use of root canal files and the factors affecting their performance. Existing improved methods (theoretical research) of root canal files have been surveyed and classified into three categories, i.e., material-based methods, geometry-based methods, and those based on additional function methods. The basic information of each classification and the advantages and limitations of each are also described in detail. And this paper further explains the percentage of different methods and determines the development trend of root canal files at this stage and the popular advance direction. In addition, this paper proposes the future development direction for root canal files based on three principal methods. The future progress of root canal files will be guided. This paper understands the state of the art and identifies future research directions for the improved methods of root canal files. It contributes to the accuracy, effectiveness, and reliability of root canal therapy. In addition, the proposal and overview of the improved methods for root canal files are of great importance in promoting the precise diagnosis and treatment of dental pulp disease and periapical disease.

Abbreviations

NiTi	Nickel-titanium
MA	Martensite
AU	Austenite
CDA	Cold drawn annealed

HT	Heat treatment
CP	Chemical polishing
GF	Good flexibility
FR	Fatigue resistance
WR	Wear resistance
IS	Improve safety
HCE	High cutting efficiency
GS	Good stability
GCR	Good chip removal
SS	Space spiral
LR	Low resistance
GC	Good convenience
NCE	No continuous embedding
IS	Improve safety
GV	Good versatility
GVI	Good visibility
STF	Structure of the file
STS	Structure of surface
STH	Structure of handle
SRS	Stress relief section
SWW	Spiral wound wire
IS	Improve safety
HA	Highly adaptable
GCR	Good chip removal
HCE	High cutting efficiency
RSC	Reduction of stress concentrations
LCS	Large cleaning space
GCR	Good chip removal
HCE	High cutting efficiency
FR	Fatigue resistance
GF	Good flexibility
IS	Improve safety
HA	Highly adaptable
GV	Good versatility
MD	Measuring device
IS	Improve safety
GS	Good stability
GV	Good versatility
GCR	Good chip removal
HTTP	Has therapeutic properties
GF	Good flexibility
GC	Good convenience
GS	Good stability
GVI	Good visibility
AM	Accuracy measurement
OTR	Optimum torque reversal
3D	Three-dimensional

Acknowledgements

Not applicable.

Author contributions

JJ and JS conceived and wrote the main sections of the review. ZH, ZB, GY, JY, and YW contributed to some sections and critically reviewed the manuscript. All the authors read and approved the final manuscript.

Funding

This work was supported by the Natural Science Foundation of Heilongjiang Province (Grant No. LH2021E081) and the Fundamental Research Foundation for Universities of Heilongjiang Province (Grant No. LGYC2018JQ016).

Availability of data and materials

Not applicable.

Declarations**Ethics approval and consent to participate**

Not applicable.

Consent for publication

Not applicable.

Competing interests

The authors declare that they have no competing interests.

Received: 9 September 2022 Accepted: 14 December 2022

Published online: 24 December 2022

References

1. Aksebzeci BH, Asyali MH, Kahraman Y, et al. Classification of root canal microorganisms using electronic-nose and discriminant analysis. *biomed Eng Online*. 2010;9:77.
2. Ng YL, Mann V, Gulabivala K. A prospective study of the factors affecting outcomes of nonsurgical root canal therapy: part 1: periapical health. *Int Endod J*. 2011;44:583–609.
3. Daooda U, Parolia A, Matinlinna J, Yiu C, Ahmed HMA, Fawzy A. Properties of a modified quaternary ammonium silane formulation as a potential root canal irrigant in endodontics. *Dent Mater*. 2020;36:e386–402.
4. Daooda U, Bapat RA, Sidhu P, Ilyas MS, Khan AS, Mak K. Antibacterial and anti-biofilm efficacy of k21-E in root canal disinfection. *Dent Mater*. 2021;37:1511–28.
5. De Paz L, Sedgley C, Kishen A. *The root canal biofilm*. Berlin: Springer; 2015.
6. Fouad AF. Endodontic microbiology and pathobiology: current state of knowledge. *Dent Clin North Am*. 2017;61:1–15.
7. Pak JG, White SN. Pain prevalence and severity before, during, and after root canal therapy: a systematic review. *J endodontics*. 2011;37:429–38.
8. VeraSiqueira JF Jr, Ricucci D, Loghin S, FernAndez N, Flores B, Cruz AG. One-versus two-visit endodontic treatment of teeth with apical periodontitis: a histobacteriologic study. *J Endod*. 2012;38:1040–52.
9. Marquis VL, Dao T, Farzaneh M. Treatment outcome in endodontics: the Toronto study, phase III: initial treatment. *J Endod*. 2006;32:299–306.
10. Molven O, Halse A, Fristad I. Periapical changes following root-canal treatment observed 20–27 years postoperatively. *Int Endod J*. 2002;35:784–90.
11. Baras BH, Sun J, Meloe MAS, Tay FR, Oates TW, Zhang K, et al. Novel root canal sealer with dimethylamino-hexadecyl methacrylate, nano-silver and nano-calcium phosphate to kill bacteria inside root dentin and increase dentin hardness. *Dent Mater*. 2019;35:1479–89.
12. Benyó B. Identification of dental root canals and their medial line from micro-CT and cone-beam CT records. *BioMed Eng Online*. 2012;11:81.
13. Nair PN, Henry S, Cano V, Vera J. Microbial status of apical root canal system of human mandibular first molars with primary apical periodontitis after “one-visit” endodontic treatment. *Oral Surg Oral Med Oral Pathol Oral Radiol Endod*. 2005;99:231–52.
14. Kararia N, Kararia V. Root canal therapy of a mandibular second premolar with atypical canal pattern. *J Conserv Dent*. 2012;15:392–4.
15. Manicone P. An overview of zirconia ceramics: basic properties and clinical applications. *J Dent*. 2007;35:819–26.
16. House KL, Pan L, O’Carroll DM, Xu S. Applications of scanning electron microscopy and focused ion beam milling in dental research. *Eur J Oral Sci*. 2022;130(2):e12853.
17. Zhu MJ, Zhong WC, Cao W, Zhang QB, Wu G. Chondroinductive/chondroconductive peptides and their-functionalized biomaterials for cartilage tissue engineering. *Bioactive materials*. 2022;4(9):221–38.
18. Adib AHH, Daphne S, Silvio V, Bernd S, Thomas G, Harald E, Marco P, Sebastian W. Visualization of inferior alveolar and lingual nerve pathology by 3D double-echo steady-state MRI: two case reports with literature review. *J imaging*. 2022;8(3):75–85.
19. Nie L, Song WT, Tao Y. Search application by combining S system and patentics in measurement field. *China Invent Pat*. 2018;15:88–92.
20. Wu Y, Zhang LW, Dai YH. Advantages of patentics in searching the technical field of apparatus for biology. *China Invent Pat*. 2019;16:119–23.
21. He X, Han X. Patentics: a retrieval and analysis tool on patent intelligence. *Inf Res*. 2014. <https://doi.org/10.3969/j.issn.1005-8095.2014.01.021>.
22. Deng SD, Xi XL, Yu J, Tong XC. Advantages of patentics in searching the technical field of apparatus for chemistry. *China Invent Pat*. 2020;17(Suppl 2):112–8.
23. Ding R. Application of different interventions of patentics for retrieval in the field of circuits. *Technol Innovat Appl*. 2019;23:180–4.
24. Liu CJ, Wu Y, Wang K. Retrieval skills of patentics in the field of biological devices. *China Invent Pat*. 2017;14:124–8.
25. Ferrari M, Pontoriero DK, Cagidiaco EF, Carboncini F. Restorative difficulty evaluation system of endodontically treated teeth. *J Esthet Restor Dent*. 2022;34:65–80.
26. Al-Obaida MI, Alzuwayer AA, Alanazi SS, Balhaddad AA. In vitro analysis of the fatigue resistance of four single file canal preparation instruments. *Materials*. 2022;15:688–96.
27. Primozic J, Hren M, Mezeg U, Legat A. Tribocorrosion susceptibility and mechanical characteristics of as-received and long-term in-vivo aged nickel-titanium and stainless-steel archwires. *Materials*. 2022;15:1427–41.
28. Faus-Matoses V, Garcia RP, Faus-Llacer V, Faus-Matoses I, Ezpeleta OA, Martinez AA, Zubizarreta-Macho A. Comparative study of the SEM evaluation, EDX assessment, morphometric analysis, and cyclic fatigue resistance of three novel brands of NiTi alloy endodontic files. *Int J Environ Res Public Health*. 2022;19:4414–27.
29. Walia HM, Brantley WA, Gerstein H. An initial investigation of the bending and torsional properties of Nitinol root canal files. *J endod*. 1988;14:346–51.
30. Gavini G, Santos MD, Caldeira CL, Machado MEDL, Iglecias EF, Peters OA, Candeiro GTDM. Nickel-titanium instruments in endodontics: a concise review of the state of the art. *Braz Oral Res*. 2018;32:45–65.
31. Padavala S, Ganapathy D. Fatigue in rotary endodontic instruments—a review. *Drug Invent Today*. 2019;11:671–6.
32. Wang Z, Luo ZW. The invention relates to a nickel-titanium alloy gradient flexible root canal file and a manufacturing method. *China patent*.CN105852991. 2016 Au 17.

33. Wang Z, Zhou JS, Sun W. The invention relates to a nickel-titanium alloy gradient flexible root canal file and a manufacturing method. China patent. CN107242911. 2017 Oct 13.
34. Zheng YS, Zhou HM, Li L, Tong YX, Han MZ. Ultra-fine grained nickel-titanium alloy root canal files and preparation method. CN102743233 China patent. 2012 Oct 24.
35. Liu S, Yang BG, Li XJ. A root canal file. China patent CN 206518610. 2017 Sep 26.
36. Steven S, Eric J. Root canal dental instrument. World Intellectual Property Organization patent. WO 2020243281. 2020 Dec 3.
37. Duan JH, Zhang XD, Song TJ, Zhou ZB. Degradable magnesium alloy root canal files. China patent. CN203677273. 2014 Jul 2.
38. Suzuki MK, Martins DA, Costa MT, Ferreira AC, Ferreira FA. Ions release evaluation and changes in mini-implant orthodontic surface. *J Contemp Dent Pract*. 2018;19(8):910–7.
39. Bonaccorso A, Schifer E, Condorelli GG, Gantatore G, Tripi TR. Chemical analysis of nickel-titanium rotary instruments with and without electropolishing after cleaning procedures with sodium hypochlorite. *J Endod*. 2008;34(11):1391–5.
40. Bui TB, Mitchell JC, Baumgartner JC. Effect of electropolishing pro file nickel-titanium rotary instruments on cyclic fatigue resistance, torsional resistance, and cutting efficiency. *J Endod*. 2008;34(2):190–3.
41. Diego PA, Isabella FDCP, Manuel H, Vicente TLB. Enhancement of NiTi super elastic endodontic instruments by TiO₂ coating. *Mater Sci Eng, C*. 2016;68(2016):675–80.
42. Derek E, Steven JA, Bennett BJ. Endodonti0063 instrument with modified memory and flexibility properties and method. United States patent US 20110159458. 2011 Jun 30.
43. Song HW, Shi CL, Li JW, Guo FR, Li HL, Deng LY. The invention relates to NiTi alloy root canal file with high fatigue life and its process. China patent CN 111685897. 2020 Jul 17.
44. Zhou JQ, Hu B. The invention discloses a preparation method of nickel-titanium alloy flexible root canal file. China patent CN 108788644. 2018 Jun 21.
45. Saghiri MA, Sheibani N, Asatourian A, Garcia-Godoy F, Saghiri MA. Anticorrosive and anti-fatigue chemical composition for nickel-titanium dental instruments and a method of synthesizing the same. United States patent US 20160024311. 2016 Jan 28.
46. Trombetta D, Mondello MR, Cimino F, Cristani M, Pergolizzi S, Saija A. Toxic effect of nickel in an in vitro model of human oral epithelium. *Toxicol Lett*. 2005;159(3):219–25.
47. Adini AR, Feldman Y, Cohen SR. Alleviating fatigue and failure of NiTi endodontic file by a coating containing inorganic fullerene-like WS nanoparticles. *J Mater Res*. 2011;26(10):1234–42.
48. Alnowailaty YA. Influence of surface coatings and surface-active liquid lubrication on cyclic fatigue of nickel-titanium rotary endodontic file in an artificial canal. State University of New York at Buffalo. 2012 Jun:26–7.
49. Liu M, Iijima M, Endo K, William A. Application of plasma immersion ion implantation for surface modification of nickel-titanium rotary instruments. *Dent Mater J*. 2007;26(4):467–73.
50. Alves-Claro APR, Claro FAE, Uzumakie T. Wear resistance of nickel-titanium endodontic file after surface treatment. *J Mater Sci Mater Med*. 2008;19(10):3273–7.
51. Tripi TR, Bonaccorso A, Condorelli GG. Fabrication of hard coatings on NiTi instruments. *J Endod*. 2003;29(2):132–4.
52. Zhang J, Sun LT, Zhao W, Zhao Y. Method for preparation of metal titanium nitro-oxide composite film for surface modification of nickel-titanium root canal files. China patent CN105908136. 2016 Aug 31.
53. Huang BM, Liu J, Xiang Y. The invention relates to multi-layer root canal file and its processing technology. China patent CN 112453828. 2021 Mar 09.
54. Tenney R, Redlich M, Ram-Adini A, Feldman Y, Navay J, Moshono J, Shea B, Beijing Kangxin Intellectual Property Agency Co. Ltd. Root canal file and preparation method thereof. China patent CN 103096830. 2013 May 8.
55. Tong YX, Li L, Zheng YF, Zhou HM. The invention relates to a surface modification method of NiTi alloy martensite root canal files. China patent CN 104630730. 2015 May 20.
56. Long XP, Sun ZL, Liu HF, Ni JZ. A 3D root canal file. China patent CN 209595930. 2019 Nov 8.
57. Long YF, Shui Y, Shen Y. Root canal swing files for root canal therapy. China patent CN 207400812. 2018 May 25.
58. Johnson WB. Dentsply Sirona, Inc. Multi-planar pre-curved rotary endodontic file. United States patent US 10136962. 2018 Nov 27.
59. Wang Z, Zhou JS, Jia XL. The utility model discloses a medical root canal file. China patent CN 209032679. 2019 Jun 28.
60. Kou WZ, Bai L, Ma LL, Fang HY, Sun JY. Root canal file. China patent CN 201676027. 2010 Dec 22
61. William J. Tulsa, OK. Dental file with improved tip configuration. European patent EP2140 828. 2010 Jun 1.
62. Bai LL, Xia LY. Shanghai Shen Xin Law Firm. Tip optimized root canal files. China patent CN 211460595. 2019 Dec 18.
63. Long XP. The utility model relates to a multi-spiral groove root canal file. China patent CN 203724240. 2014 Jul 23.
64. Long YF, Shui Y. The utility model relates to a vertical dental file. China patent CN 209933021. 2020 Jan 14.
65. Long XP. Reciprocating left-edged root canal file. China patent CN 203943750. 2014 Nov 19.
66. Farrag OAS, Bryn Mawr PA. Endodontic instrument. United States patent US 11083539. 2021 Aug 10.
67. Long YF, Shui Y. The invention relates to a root canal file with a discontinuous helical cutting edge. China patent CN 109498186. 2019 Mar 22.
68. Fan ZY, Jiang JQ, Quan JJ, Ren ZF. A multi-pyramid root canal file. China patent CN 213552491. 2021 Jun 29.
69. Li G. Shanghai simuda patent agency. a root canal file. China patent CN 211884087. 2020 Nov 10.
70. Lampert CJ, Lake Oswego OR. Endodontic instrument and instrument system. United States patent US 20100119990. 2010 May 13.
71. Dabar Zalka NB, Metn Endodontic instruments and root canal therapy methods. European patent application patent EP 3170471. 2017 May 24.
72. Liu S, Yang BG, Li XJ. The utility model relates to a root canal file for treating molar teeth. China patent CN 206518609. 2017 Sep 26.

73. Lu Y, Geng X. The utility model relates to a microscopic H-type root canal file. China patent CN 211049650. 2020 Jul 21.
74. Dai QY, Chen XM, Zhang LP, Han SL, Liu K. A bent root canal file. China patent CN 206910406. 2018 Jan 23.
75. Yang J, Tang DF. The utility model relates to a deformable root canal file. China patent CN 205339178. 2016 Jun 29.
76. Zhang DB, Bai GL, Ma LZ. The utility model relates to a floating root canal file. China patent CN 108542513. 2018 Sep 18.
77. Hof R, Teperovich E, Zilbershtain AM. Redent-Nova Ltd. Self-adjusting instrument. United States patent US 20110081623. 2011 Apr 7.
78. Wang SN, Wang JB, Lin DZ, Li XH, Cui Y, Li JT, Zhu K. The invention relates to a deformable nickel-titanium root canal file. China patent CN 208114663. 2018 Nov 20.
79. Huang BM, Liu J, Xiang Y. The invention relates to a laminated compound root canal file and its processing technology. China patent CN 110497163. 2019 Nov 26.
80. Huang BM, Liu J, Xiang Y. The invention relates to a three-dimensional self-adjusting root canal file and its processing technology. China patent CN 110693615. 2020 Jan 17.
81. Lavkesh B. Rotary endodontic file in basket form. World Intellectual Property Organization patent WO 2018002951. 2018 Jan 4.
82. Becker A, Berkovich S, Katan U. Medic NRG Ltd. Endodontic file. United States patent US 20140045142. 2014 Feb 13.
83. Becker A, Levy H, Rothenstein S. Medic NRG Ltd. Rotary endodontic file with frictional grip. United States patent US 20110212413. 2011 Sep 1.
84. Becker A, Berkovich S, Levy H. Medic NRG Ltd. Endodontic file having an outer spiral cord. United States patent US 9585731. 2017 Mar 7.
85. Li M, Zhang HM, Feng B, Zhang J, Dai LX, Tang Df. The utility model relates to a nickel-titanium root canal file for counting, the number of times of use. China patent CN 209107620. 2019 Jul 16.
86. Zhang DB, Xie J, Wu JY. A novel countable root canal file. China patent CN 108542512. 2018 Sep 18.
87. Zhang DB, Xie J, Wu JY. A countable root canal file. China patent CN 108433831. 2018 Aug 24.
88. Fang HY, Kou WZ, Bai L, Sun JY. Mechanical root canal files. China patent CN 202437374. 2012 Sep 19.
89. Ge R. The utility model relates to a dental root canal file. China patent CN 209004247. 2019 Jun 21.
90. Mi BB, Liu GH, Liu J, Xiong Y, Jiang M. The invention discloses a root canal file preventing fracture and a manufacturing method thereof. China patent CN 113081324. 2017 Jul 9.
91. Kim HW. Endodontic file for dental endodontic treatment. European patent application patent. EP 3597141. 2020 Jan 22.
92. Kim HW, Kim GH, Kim SY. Endo file for dental endodontic treatment. United States patent US 20160128800. 2016 May 12.
93. Shotton V, Ammon D. Endodontic instruments. United States patent US 20150216624. 2015 Aug 6.
94. Long XP. Convex nickel-titanium root canal file. China patent CN 204446150. 2015 Jul 8.
95. Wang Z, Luo ZW. The invention relates to an elastic root canal file with non-equiaxial section. China patent CN 206044757. 2017 Mar 29.
96. Zhong S, Yi A, Wan J. A new type of root canal file body. China patent CN 206910405. 2018 Jan 23.
97. Yue B, Sun ZL, Ma MD, Chen HY. Minimally invasive root canal files. China patent CN 209884369. 2020 Jan 3.
98. Liu S, Li XJ, Wang ZN. An efficient root canal file for treating root canals. China patent CN 206995351. 2018 Feb 13.
99. Liu S, Yang BG, Ma LZ. The utility model relates to a root canal file with high crack resistance. CN 204446152. 2015 Jul 8.
100. Liu S, Yang BG, Ma LZ. The invention relates to a nickel-titanium open file for establishing a straight canal channel. CN 204446154. 2015 Jul 8.
101. Liu S, Yang BG, Ma LZ. The utility model relates to a D-type root canal file with high strength and crack resistance. CN 204446155. 2015 Jul 8.
102. Jaunberzins A. Endodontic instrument with narrow radial lands. United States patent US 20170135786. 2017 May 18.
103. Jaunberzins A. Endodontic file combining active and passive cutting edges. United States patent US 20100297578. 2010 Nov 25.
104. Zhou LM, Cui ZJ. A root canal file. China patent CN 209611357. 2019 Nov 12.
105. William BJ. Reciprocal reverse rotation endodontic file. United States patent US 20100040994. 2010 Feb 18.
106. McSpadden JT. Endodontic file with multi-tapered flutes. United States patent US 20100255442. 2010 Oct 7.
107. Hao ZY, Guo G, Wang CC. Medical root canal files. China patent CN 202477881. 2012 Oct 10.
108. Chi HY, Xiao LL. A dental root canal file. China patent CN 214414938. 2021 Oct 19.
109. Luo WC, Ren Z. The utility model relates to an anti-shedding hand root canal file. China patent CN 204890207. 2015 Dec 23.
110. Wang LX, Tian FJ. The utility model relates to a non-equiaxial section root canal file. China patent CN 209899615. 2020 Jan 7.
111. Sun QX, Li PJ, Yang D. The utility model relates to a hand root canal file. China patent CN 203790060. 2014 Aug 27.
112. Zheng YX, Zheng Z. Adjustable root canal file. China patent CN 203564347. 2014 Apr 30.
113. Ramos CAS, Tuttle RD. Combined use of ultrasound with nickel-titanium endodontic file in endodontic procedure. United States patent US 20160022377. 2016 Jan 28.
114. Tian FJ; The utility model relates to a root canal file for root washing. China patent CN 212089798. 2020 Dec 8.
115. Long XP, Sun ZL, Liu HF, Ni JZ. The utility model relates to a hollow root canal file for easy flushing. China patent CN 211796958. 2020 Oct 30.
116. Zeev S. Device for shaping and simultaneous flushing and suction of a tooth root canal. World Intellectual Property Organization patent WO 2021144465. 2021 July 22.
117. Xu YT. The utility model relates to a root canal file for root irrigation. China patent CN 208989188. 2019 Jun 18.

118. Ann MK, Ray DD, Arlin GJ, Fatima T, Alan BK, Neil Q. University of iowa research foundation. light-based dental treatment device. World Intellectual Property Organization patent WO 2018009864. 2018 Jan 11.
119. Obada D. Laser emitting orthodontic assembly. United States patent US 20210244499. 2021 Aug 12.
120. Dana YAR, Rashid MEA. Instrument to bypass fractured fragments of endodontic rotary file in a root canal of a tooth. World Intellectual Property Organization patent WO 2021186224. 2021 Sep 23.
121. Radwan S. Method and extraction device for removal of broken root canal file fragment. United States patent US 10813719. 2020 Oct 27.
122. Hou DQ, Dong Y, Gao ZB, Wu Y. A root canal file. China patent CN 207545234. 2018 Jun 29.
123. Huang Y, Zhang Q, Wei DL, Wang Y, He H, He S, Yang QP, Wu X, Bai R, Zhou R, Wu X, Bai D, Han XL, Zhang MJ. The utility model relates to a root canal measuring file with an external scale. China patent CN 206403877. 2017 Aug 15.
124. Zhu TT, Wang Y, Li SJ, Zhang Q, Liao C. A new root canal measuring file. China patent CN 205279948. 2016 Jun 1.
125. Bagheri MJ. Endodontic hand file and methods for attachment. United States patent US 20190125508. 2019 May 2.
126. Du Y, Gao Y, Yang Y, Ou L, Guo B, Zhou MH. A file for canal length measurement. China patent CN 206381250. 2017 Aug 8.
127. Cai QS, Jin H. K-shaped root canal file with metal ring. China patent CN206151607. 2017 May 10.
128. Curry AD, Dykes DE, Frommeyer AX, Schab JA. Endodontic file with working length adjustment scale. United States patent US 20110300506. 2011 Dec 8.
129. Zhang XR, Kong YY, Jiang QZ, Feng Q, Huang YT, Ren Z. A root canal file containing a miniature video camera. China patent CN 205626145. 2016 Oct 12.
130. Alghamdi A, Alsofi L, Balto K. Effects of a Novel NiTi thermomechanical treatment on the geometric features of the prepared root canal system. *Materials*. 2021. <https://doi.org/10.3390/ma1323546>.
131. Martins JNR, Silva EJNL. Multimethod assessment of design, metallurgical, and mechanical characteristics of original and counterfeit ProGlider instruments. *Materials*. 2022. <https://doi.org/10.3390/ma15113971>.
132. Falakaloglu S, Silva EJNL, Ozata MY. Shaping ability of different NiTi rotary systems during the preparation of printed mandibular molars. *Aust Endod J*. 2022. <https://doi.org/10.1111/aej.12649>.
133. Martins JNR, Silva EJNL, Marques D. Comparison of design, metallurgy, mechanical performance and shaping ability of replica-like and counterfeit instruments of the ProTaper next system. *Int Endod J*. 2021. <https://doi.org/10.1111/iej.13463>.
134. Silva EJNL, Martins JNR, Ajuz NC. A multimethod assessment of a new customized heat-treated nickel-titanium rotary file system. *Materials*. 2022. <https://doi.org/10.3390/ma15155288>.
135. Zhou X, Jiang S, Wang X, et al. Comparison of dentinal and apical crack formation caused by four different nickel—titanium rotary and reciprocating systems in large and small canals. *Dent Mater J*. 2015;34:903–9.
136. Monga P, Bajaj N, Mahajan P, et al. Comparison of incidence of dentinal defects after root canal therapy with continuous rotation and reciprocating instrumentation. *Singapore Dent J*. 2015;36:29–33.
137. Liu R, Hou BX, Wesselink PR, et al. The incidence of root micro—racks caused by 3 different single—file systems versus; the ProTapersystem. *J Endod*. 2013;39:1054–6.
138. Zhang J, Ge JY, Sun WB. Mtwo Advances in nickel-titanium instruments. *Int J Stomatol*. 2009;36:607–9.
139. Caviedes-Bucheli J, Azuero-Holguin MM, Gutierrez-Sanchez L, et al. The effect of three different rotary instrumentation systems on substance P and calcitonin gene—related peptide expression in human periodontal ligament. *J Endod*. 2010;36:1938–42.
140. Caviedes-Bucheli J, Moreno JO, Carreno CP, et al. The effect of single - file reciprocating systems on substance P and calcitonin gene—related peptide expression in human periodontal ligament. *Int Endod J*. 2013;46:419–26.
141. Vande Visse JE, Billiant JD. Effect of irrigation on the production of extruded material at the root apex during instrumentation. *J Endod*. 1975;1:243–6.
142. Pereira ES, Peixoto IF, Viana AC, et al. Physical and mechanical properties of a thermomechanically treated NiTi wire used in the manufacture of rotary endodontic instruments. *Int Endod J*. 2012;45:469–74.
143. Ye J, Gao Y. Metallurgical characterization of M-Wire nickel-titanium shape memory alloy used for endodontic rotary instruments during low-cycle fatigue. *J Endod*. 2012;38:105–7.
144. Burklein S, Schafer E. Apically extruded debris with reciprocating single- file and full - sequence rotary instrumentation systems. *J Endod*. 2012;38:850–2.
145. Bane K, Faye B, Sarr M, et al. 2015 Root canal shaping by single-file systems and rotary instruments a laboratory study. *Iran Endod J*. 10:135-9.
146. Berutti E, Chiandussi G, Paolino DS, et al. Effect of canal length and curvature on working length alteration with WaveOne reciprocating files. *J Endod*. 2011;37:1687–90.
147. Burklein S, Hinschitzka K, Dammaschke T, et al. Shaping ability and cleaning effectiveness of two single-file systems in severely curved root canals of extracted teeth: reciproc and WaveOne versus Mtwo and ProTaper. *Int Endod J*. 2012;45:449–61.
148. De Souza PF, Oliveira Goncalves LC, Franco Marques AA, et al. Root canal retreatment using reciprocating and continuous rotary nickel—titanium instruments. *Eur J Dent*. 2015;9:234–9.
149. Kimura S, Ebihara A, Maki K, Nishijo M, Tokita D, Okiji T. Effect of optimum torque reverse motion on torque and force generation during root canal instrumentation with crown-down and single-length techniques. *J Endod*. 2020;46:232–7.
150. Papageorgiou DG, Kinloch IA, Young RJ. Mechanical properties of graphene and graphene-based nanocomposites. *Prog Mater Sci*. 2017. <https://doi.org/10.1016/j.pmatsci.2017.07.004>.
151. Denry I, Kelly JR. Emerging ceramic-based materials for dentistry. *J Dent Res*. 2014. <https://doi.org/10.1177/0022034514553627>.
152. Elahinia M, Moghaddam NS, Andani MT. Fabrication of NiTi through additive manufacturing: a review. *Prog Mater Sci*. 2016. <https://doi.org/10.1016/j.pmatsci.2016.08.001>.

153. Huang ZY, Shao GB, Li LQ. Micro/nano functional devices fabricated by additive manufacturing. *Prog Mater Sci.* 2023;131:101020.
154. Kaur M, Singh K. Review on titanium and titanium based alloys as biomaterials for orthopaedic applications. *Mat Sci Eng C-mater.* 2019. <https://doi.org/10.1016/j.msec.2019.04.064>.
155. Hsissou R, Seghiri R, Benzekri Z. Polymer composite materials: a comprehensive review. *Compos Struct.* 2021. <https://doi.org/10.1016/j.compstruct.2021.113640>.
156. Elbaz A, He ZZ, Gao BB. Recent biomedical applications of bio-sourced materials. *Bio-des Manuf.* 2018. <https://doi.org/10.1007/s42242-018-0002-5>.
157. Sun JY, Liu C, Bhushan B. A review of beetle hindwings: structure, mechanical properties, mechanism and bioinspiration. *J Mech Behav Biomed.* 2019. <https://doi.org/10.1016/j.jmbbm.2019.02.031>.
158. Zhang J, Zhang Q, Ge Y, Jiang Y. Analysis of the wear-resistance characteristics of bionic ridge structures. *Appl Eng Agric.* 2020. <https://doi.org/10.13031/aea.13680>.
159. Liu JQ, Gao YC, Lee YJ, Yang S. Responsive and foldable soft materials. *Trends Chem.* 2020. <https://doi.org/10.1016/j.trechm.2019.11.003>.
160. Zhang DY, Wang Y, Cai J. Bio-manufacturing technology based on diatom micro- and nanostructure. *Chinese Sci Bull.* 2012. <https://doi.org/10.1007/s11434-012-5410-x>.
161. Hackett M, Proctor M. Three-dimensional display technologies for anatomical education: a literature review. *J Sci Educ Technol.* 2016. <https://doi.org/10.1007/s10956-016-9619-3>.
162. Xu FJ, Xu YL, Zhang HJ. Application of sensing technology in intelligent robotic arc welding: a review. *J Manuf Process.* 2022. <https://doi.org/10.1016/j.jmapro.2022.05.029>.
163. Feng T, Fan FY, Bednarz T. A review of computer graphics approaches to urban modeling from a machine learning perspective. *Front Inform Tech El.* 2021. <https://doi.org/10.1631/FITEE.2000141>.
164. Wang WY, Siau K. Artificial intelligence, machine learning, automation, robotics, future of work and future of humanity: a review and research agenda. *J Database Manage.* 2019. <https://doi.org/10.4018/JDM.2019010104>.

Publisher's Note

Springer Nature remains neutral with regard to jurisdictional claims in published maps and institutional affiliations.

Ready to submit your research? Choose BMC and benefit from:

- fast, convenient online submission
- thorough peer review by experienced researchers in your field
- rapid publication on acceptance
- support for research data, including large and complex data types
- gold Open Access which fosters wider collaboration and increased citations
- maximum visibility for your research: over 100M website views per year

At BMC, research is always in progress.

Learn more biomedcentral.com/submissions

